

Pacioli 19

The role of FADN after the CAP reform



LEI

WAGENINGENUR

Pacioli 19

The role of FADN after the CAP reform

Hans Vrolijk (ed.)

LEI Memorandum 12-014

February 2012

Project code 2275000383

LEI, part of Wageningen UR, The Hague

LEI is active in the following research areas:



Agriculture & Entrepreneurship



Regional Economy & Land Use



Markets & Chains



International Policy



Natural Resources



Consumer & Behaviour

Pacioli 19; The role of FADN after the CAP reform

Vrolijk, H. (ed.)

LEI Memorandum 12-014

ISBN/EAN: 978-90-8615-572-9

Price € 34,75 (including 6% VAT)

186 p., fig., tab., app.

The international Pacioli network shares knowledge on the management and use of agricultural micro-economic databases (such as the Farm Accountancy Data Network in Europe). Each year LEI, part of Wageningen UR, organizes a Pacioli workshop in close cooperation with a local organizer. The 19th Pacioli workshop took place in Tallinn, Estonia in October 2011.

Photo cover: Hans Vrolijk

Orders

+31 70 3358330

publicatie.lei@wur.nl

This publication is available at www.lei.wur.nl/uk

© LEI, part of Stichting Dienst Landbouwkundig Onderzoek (DLO foundation), 2012

Reproduction of contents, either whole or in part, is permitted with due reference to the source.

Contents

	Preface	8
1	Introduction	9
	1.1 19th Pacioli workshop	9
	1.2 Programme of the 19th Pacioli workshop	9
2	The comparative analysis of organic and conventional farming in Estonia	11
3	Farm Characterization and Modelling in Risk Management; Case of Crop Farm Data in Canada	19
4	Productivity development of Finnish agricultural sector based on FADN data	25
	4.1 Introduction	25
	4.2 Productivity trend in Finnish agriculture	25
	4.3 Calculation procedure	26
	4.4 Data and prices	26
	4.5 Farm level indices and group averages	26
	4.6 Reporting of results	28
	4.7 References	29
5	Analysis of production costs of milk - a comparison of economic estimates versus allocation schemes	30
	5.1 Introduction	30
	5.2 Method and data	30
	5.3 Costs for selected EU countries based on estimates or allocation schemes	32
	5.4 Comparison of costs and margins derived by estimates and the allocation scheme	36
	5.5 Extending the approach towards full costs	37
	5.6 Extension towards cost functions	39
	5.7 Conclusions	41
	5.8 References	42
	5.9 Annex 5.1 Aggregation of regions	43
	5.10 Annex 5.2 Number of observations in samples	43
6	The value of land according to data from the Italian FADN	44
	6.1 Introduction	44
	6.2 An outline of the determining forces behind the value of agricultural land	44
	6.3 Statistical characteristics of the FADN sample and the features of the study	46
	6.4 Available information, selection of study references and methods for estimating the variables which characterise the agricultural land market	48
	6.5 Comments on the obtained results: economic aspects and the market dynamic	52
	6.6 Comparative examination of the study results	57
	6.7 Concluding remarks	61
	6.8 References	63
7	The incidence Farm Programs and the value of farm assets	65
	7.1 References	74

8	Working group session 1: FADN and the financial crises	75
	8.1 Results	75
	8.2 Extent to which the financial crises have affected current or future budgets for FADN	75
	8.3 Define and discuss strategies to prevent such budget cuts	75
	8.4 Define measures to implement budget cuts	76
9	Balancing emerging data needs, preserving the core statistical program and controlling response burden and budgets: a utopia?	78
10	Policy analysis based on micro-economic data conducted at JRC-IPTS Agrilife Unit and Future data needs. Selected activities	85
11	Unpaid family labour analysis on FADN farms	97
	11.1 Introduction	97
	11.2 Factors affecting labour use and costs	97
	11.3 Data	98
	11.4 Regional study	99
	11.5 Conclusions	103
	11.6 References	103
12	Electronically transmission of data in Norwegian agricultural sector	104
	A concerted action for effective exchange of farm level data in Norway	104
	12.1 Introduction	104
	12.2 Main conclusions from the pilot project	104
	12.3 Main project	105
	12.4 Collection of data	110
	12.5 Quality of the data	110
	12.6 Use of data	110
	12.7 Bottlenecks	111
	12.8 Conclusions	111
	12.9 References	112
13	Storage of farm data online (via internet)	113
14	Application of FADN and other information systems in the management of the advisory service in agriculture	117
	14.1 Introduction	117
	14.2 Organizational set-up	117
	14.3 The advisory service	119
	14.4 Organizational development	120
	14.5 Coordinative groups	120
	14.6 Improved planning, monitoring and evaluation	121
15	Use of FADN data for appraising sustainability of Italian farms, strengths and weaknesses of the current database	125
	15.1 Introduction	125
	15.2 A short literature review on the assessment of sustainability	126
	15.3 Methodology	127
	15.4 First findings	130
	15.5 Final remarks	132
	15.6 Acknowledgments	133
	15.7 References	133

16	Working group 2: FADN indicators and info graphics	135
	16.1 Results	135
	16.2 FADN indicators and info graphics	135
	16.3 Practical applications or ideas for visualising FADN results	136
17	First practical experiences with random sampling	137
18	Technical innovation in the Dutch dairy sector	146
19	Total calculation based on weighted farm level accounting data	155
20	Overview of Statistical and Methodological Developments in the Farm Business Survey in England	158
21	Unit Cost calculation based on FADN-data (77 products/530 cost items)	171
22	Proposal for the enhancement of the EU FADN	180
	Participant list	184

Preface

For the 19th time LEI organised the yearly Pacioli workshop. This time, it took place in Tallinn, Estonia, from 2 to 5 October 2011. The workshop was attended by 38 participants from eighteen countries. Participants from EU countries, candidate countries, but also countries outside the EU such as Norway and Switzerland were welcomed. Furthermore, the workshop was attended by representatives from the USDA, Statistics Canada, OECD and European Commission.

The workshop was opened by Andres Oopkaup, Deputy Secretary General for Agricultural and Trade Policies of Estonia. Topics discussed during the workshop were among others production costs of agricultural products, productivity analysis in agriculture, risk management in agriculture, innovation in the dairy sector and the measurement of the sustainability of the farming sector. Other topics were on the efficiency and administrative burden of data collection and processing.

The Rural Economy Research Centre based in Janeda Estonia was kind enough to make the local arrangements in Tallinn. LEI was responsible for organising the content of the programme and chairing the meetings. We would like to thank Marju Aamisepp for the local organisation of the workshop. Martin Beau-
lieu contributed to this report by summarising the results of the working groups.

L.C. van Staalduinen MSc
Managing Director LEI

1 Introduction

1.1 19th Pacioli workshop

In cooperation with the Rural Economy Research Centre in Janeda, Estonia, LEI, part of Wageningen UR, organised the 19th Pacioli workshop which took place in Tallinn between 2 and 5 October 2011.

1.2 Programme of the 19th Pacioli workshop

Sunday, 2 October 2011

20.00 Get together for informal drink

Monday, 3 October 2011

08.45	<i>Opening</i> Andres Oopkaup	- Deputy Secretary General for Agricultural and Trade Policies, Introduction of Estonian Agriculture
	Hans Vrolijk	- Introduction Workshop
09.30	<i>Paper Session I</i> Eduard Matveev	- The Comparative Analysis of Organic and Conventional Farming in Estonia
	Shingo Kimura	- Farm characterization and modelling in risk management: the case of crop farm data in Canada
	Olli Rantala	- Productivity development of Finnish agricultural sector based on FADN data
11.00	Break	
11.15	<i>Paper Session II</i> Werner Kleinhanss	- Analysis of production costs of milk - a comparison of economic estimates versus allocation schemes
	Concetta Cardillo	- The value of land. A contribution to the knowledge of the Italian agricultural land market through the FADN data
	Jennifer Ifft	- The Incidence of Farm Programs and the Value of Farm Assets
12.45	Lunch	
13.45	<i>Workgroup Session I</i> FADN and the Financial crises, how to cope with threat of budget cuts	
15.45	Break	
16.00	<i>Paper Session III</i> Martin Beaulieu	- Balancing emerging data needs, preserving the core statistical program and controlling response burden and budgets: a utopia?
	Maria Espinosa	- Policy analysis based on micro-economic data conducted at the JRC-IPTS Agrilife Unit and Future data needs. Selected Activities
	Minna Väre	- Unpaid family labour analysis on FADN farms
17.30	Break	

- 18.00 - 19.00 *Paper Session IV*
 Haukas Torbjorn - Electronically transmission of data in Norwegian agricultural sector
 Sami Chaudhary - Storage of farm data online (via internet)
 20.00 Dinner

Tuesday, 4 October 2011

- 9.00 *Paper Session V*
 Vesna Ilievska, - Application of FADN and other information systems in the management of the advisory service in agriculture
 Zoran Bardako,
 Lars Olsson
 Jan Pierrick - Analyzing the link between farm economic and environmental performance by combining FADN and LCA data
 Antonella Bodini - Use of FADN data for appraising sustainability of Italian farms, strengths and weaknesses of the current database
 10.30 Break
 10.45 *Workgroup Session 2*
 Presenting key messages from FADN data, indicators and info graphics
 12.30 Lunch
 13.30 -22.00 *Excursion with dinner*

Wednesday, 5 October 2011

- 9.00 *Paper Session VI*
 Andreas Roesch - First practical experiences with random sampling
 Pieter Willem Blokland - Growth, investments and consequences for financial results of EU dairy farms
 Maria Yli-Heikkilä - Total calculation based on weighted farm level accounting data
 10.30 Break
 10.45 *Paper session VII*
 Selina Matthews, - Overview of Statistical and Methodological Developments in the Farm Business Survey in England'
 Andrew Woodend
 Arto Latukka - Unit Cost calculation based on FADN-data (77 products/ 530 cost items)
 Bernd Kuepker - Proposal for the enhancement of the EU-FADN
 12.30 Lunch
 13.30 Leave for the airport

2 The comparative analysis of organic and conventional farming in Estonia

Eduard Matveev

PACIOLI 19
TALLINN, ESTONIA, 2-5 October 2011

The Comparative Analysis of Organic and Conventional Farming in Estonia

Eduard Matveev
Rural Economy Research Centre



Introduction

- In Estonia, organically farmed land has expanded more than ten times since 2000.
 - As of the end of year 2010, 121 814 hectares (i.e 13% of total agricultural area) in Estonia were managed organically by 1 356 organic farms.
 - On the other hand the processing and marketing are still poorly developed in Estonia.
 - In 2010, the average farm size was about 90 ha.
 - Six of Estonia's largest organic farms have over 1000 hectares of land.
-

2

Data sources

- Rural Economy Research Centre (RERC)
 - Farm Accountancy Data Network (FADN) data
- Agricultural Registers and Information Board (ARIB)
 - Register of agricultural supports
 - Register of agricultural animals
 - Field Register
- Agricultural Board (AB)
 - Register of organic farming

3

Structure of the population of organic holdings, 2010

Type of farming	Standard output (thous €)									All	%
	...<2	2-<4	4-<8	8-<15	15-<25	25-<50	50-<100	100-<250	250-<...		
A Field crops	45	38	64	35	28	31	15	6	3	265	20%
B Horticulture	9	5	3	6	1	2	2			28	2%
D Permanent crops	65	7	8	5	2	2				89	7%
E Milk		3	7	11	13	18	10	15	6	83	6%
F Grazing livestock	24	43	111	139	116	102	60	27	2	624	46%
G Granivores	2		2	1		1	1	1		8	1%
H Mixed	43	41	57	53	22	22	16	4	1	259	19%
All	188	137	252	250	182	178	104	53	12	1 356	100%
%	14%	10%	19%	18%	13%	13%	8%	4%	1%	100%	

4

The representativity of the population of organic farms, 2010

SO ('000 €)	Number of holdings (%)	Cumulative (%)	Standard output (SO) ('000 €)	Cumulative (%)	Arable land (ha)	Cumulative (%)
...<2	188 14%	14%	181 1%	1%	1 097 1%	1%
2-<4	137 10%	24%	410 1%	2%	1 859 1%	2%
4-<8	252 19%	43%	1 439 4%	6%	6 283 5%	7%
8-<15	250 18%	61%	2 781 8%	14%	10 913 9%	16%
15-<25	182 13%	74%	3 515 10%	24%	14 171 11%	28%
25-<50	178 13%	88%	6 364 18%	43%	24 779 20%	48%
50-<100	104 8%	95%	7 227 21%	63%	28 975 23%	71%
100-<250	53 4%	99%	7 859 23%	86%	25 914 21%	92%
250-<...	12 1%	100%	4 770 14%	100%	10 329 8%	100%
All	1 356 100%		34 547 100%		124 320 100%	

Development of organic farming in Estonia, 2002 – 2010

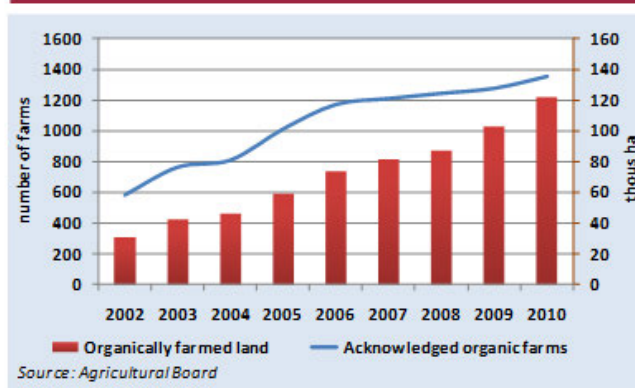

6

Organically farmed land, 2004 – 2010

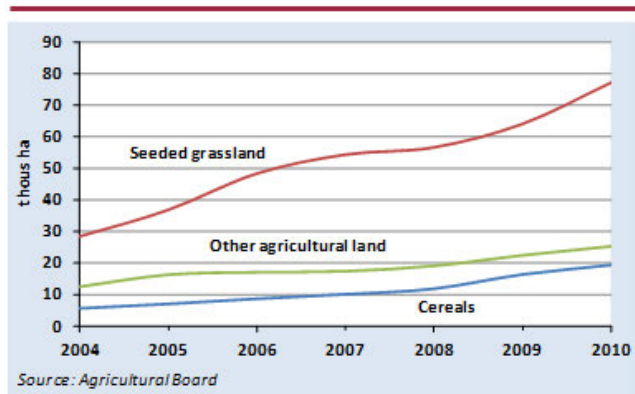

7

Share of subsidies in total income of organic farms, 2004 - 2009

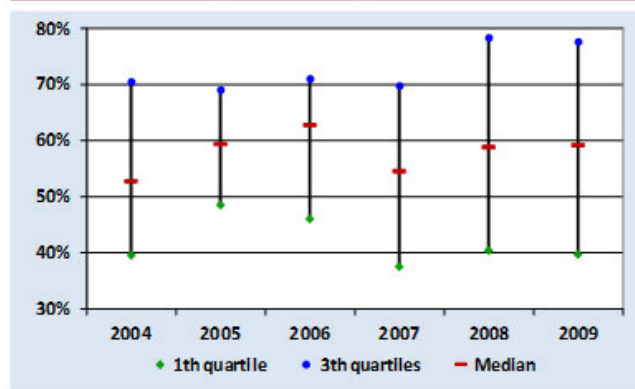

8

The Lorenz curve for support payments, 2010

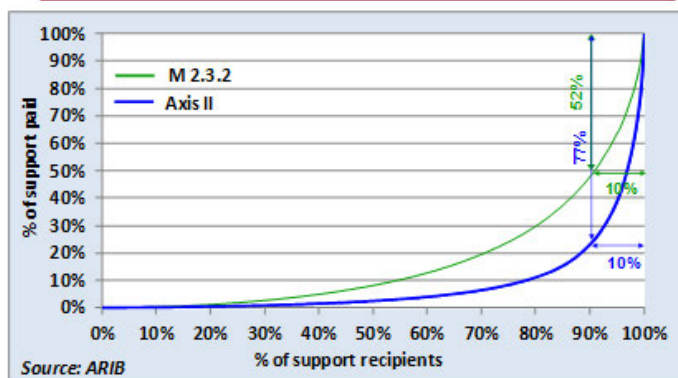

9

Gini coefficients for support payments, 2010

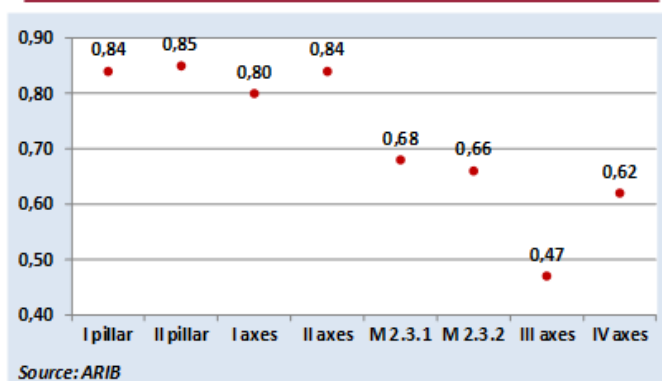

10

Yield of wheat 2000-2009

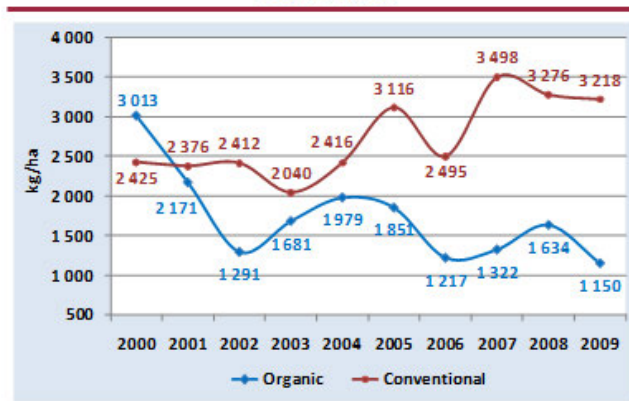

11

**Average milk yield per cow
2000-2009**

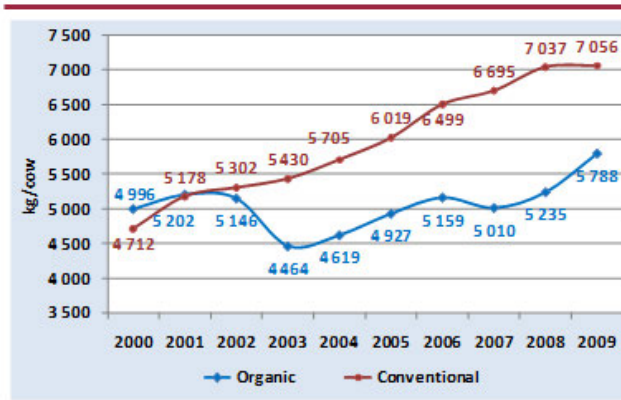

12

**Subsidies per hectare of
agricultural land, 2000-2009**

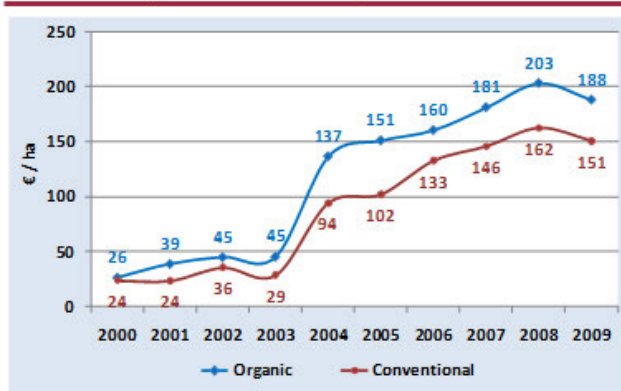

13

**Share of subsidies in gross output
2000-2009**

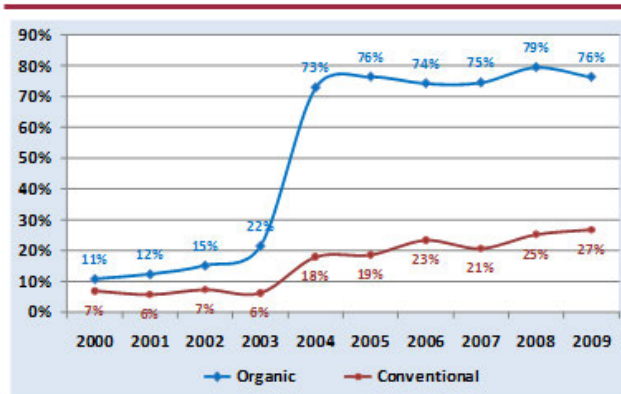

14

The output and input ratio (excl. subsidies) 2000-2009

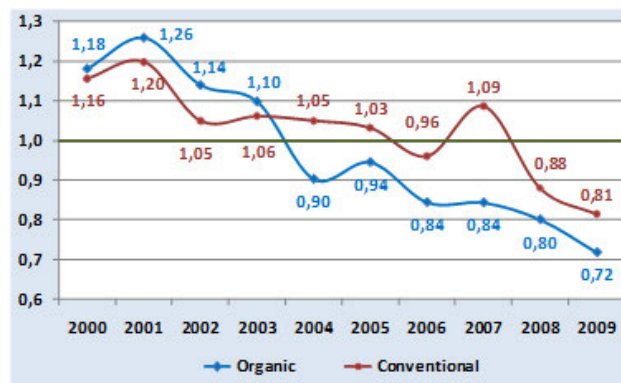

15

Net value added per annual work unit 2000-2009

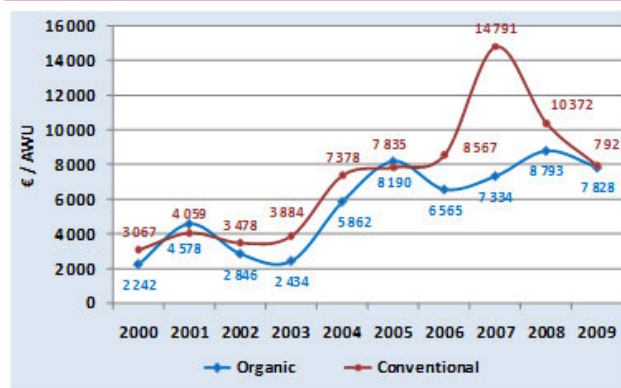

16

Share of subsidies in NVA 2000-2009

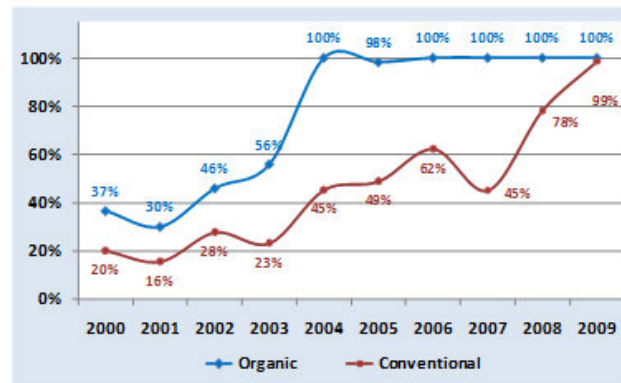

17

Investments per hectare of agricultural land, 2000 - 2009

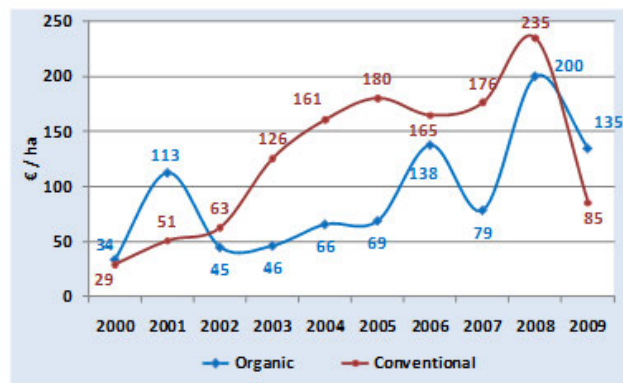

18

The debt ratio 2000 - 2009

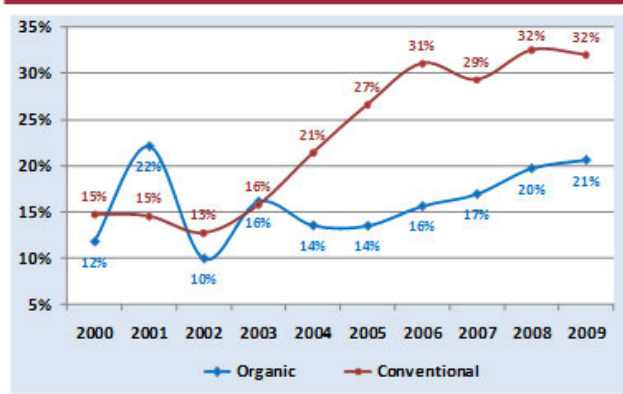

19

Conclusions

- Conventional farms are significantly more efficient than organic farms.
 - The economic situation of organic farms in Estonia is generally unsatisfactory.
 - The NVA per AWU was on average higher in conventional farms than in the organic farms.
 - The subsidies are very important for the economic viability of Estonian organic farms.
 - The share of subsidies in gross output is much higher for organic farms than for conventional farms.
-

20

Eduard Matveev
eduard@maainfo.ee

Rural Economy Research Centre
www.maainfo.ee



3 Farm Characterization and Modelling in Risk Management; Case of Crop Farm Data in Canada

Shingo Kimura



Shingo Kimura
OECD Trade and Agriculture

PACIOLI 19 Conference
Tallinn, October 3 2011

Overview of Presentation

1. OECD Network for Farm-Level Analysis
2. Challenge of using farm-level data for policy analysis
3. Policy simulation by farm
4. Farm clustering as an alternative method to model multiple representative farms
5. Example of policy simulations: Climate change scenario and risk management instruments in Canada

OECD Network for Farm-Level Analysis

- Launched in 2008 to enhance OECD work using farm-level analysis
- It provides a forum of interactions among experts in member countries
- Meet twice a year in Paris
- Next meeting on 3-4 November 2011, with more participating countries

Examples of OECD work using farm level analysis

1. Distribution of Support and Income

- Going beyond average support level discussion: Who receives more support?

2. Risk Management in Agriculture

- Going beyond estimating risk by aggregate price and production data: What is the degree of risk exposure at farm-level?

3. Productivity and Innovation

- Going beyond sector level productivity growth: Who is an innovative farm? What is the dynamics of productivity growth?

Challenge of using farm-level data for policy analysis

- Panel data allows to calculate risk exposure of individual farm
- Comparison of risk across individual farms often provides more inference than simple averaging of risk

For example...

Percentage of farms with higher yield CV than price CV

		Australia	UK	Italy	Estonia
Higher yield risk than price risk	Wheat	51	11	25	68
	Barley	23	18	72	69
	Oilseed	75	51	n.a.	n.a.
	Oat	33	n.a.	70	72

Policy Simulation by farm

- Simple policy simulation of can be applied for all farms, without endogenous farm decision.
- But..**dilemma** still remains how to aggregate simulation results of all farms

For example, simulation of payments is conducted for all 402 crop farms in Saskatchewan, Canada

	Expected receipt per farm (CAD)	Mean percentage reduction of variance	Percentage of farms with reduced variance	Percentage of farms with higher minimum income
Gross margin of agricultural production	22220	-	-	-
+ Indemnity from insurance	27310	-12.89	69.8	64.1
+ AgriStability payment without lag	26474	-4.14	96.3	90.2
+ AgriStability payment with one year lag	26471	0.32	45.7	42.0
+ AgriStability payment with two years lag	26468	0.95	43.5	40.0
+ AgriStability payment with two checks	26472	0.67	41.8	63.7

OECD Trade & Agriculture

6

Policy Simulation by farm

- However... farm by farm simulation becomes **challenging** when it comes to **modelling of individual farm with endogenous decision**

For example, OECD study presents the simulation result for only one representative farm (usually calibrated as an average farm)

	Certainty equivalent income (change in CAD)		CV of Income (Change in Percentage)	Change in Diversification Index (Initial=100)	Minimum Income (change in CAD)	Change in the share of land insured (change in percentage points)
	Overall change	Contributing factors (Change in mean variability)				
Total impacts	\$296.5	\$250.1	46.3	-7.7	-30.0	12914.1
contribution of....						
AgriInsurance	10.8	-4.2	15.0	-0.5	-3.9	5424.2
AgriInvest	484.4	483.9	0.5	-0.7	0.0	479.6
AgriStability	3789.2	3634.2	135.1	-9.0	-17.8	12388.6
AgriRecovery	1032.1	1136.3	-104.2	2.5	-8.3	-5378.4
in case of AgriStability with lag	3317.4	3285.4	32.0	-4.9	-17.8	11551.4

OECD Trade & Agriculture

7

Farm characterization by risk

- Alternatively, farm clustering by key farm characteristics allows the modelling of multiple representative farms.

For example, clustering methods allow 402 Canadian crop farm data to group to **3 clusters by risk characteristics (low, medium and high risk farms)**

Risk Cluster	Low	Medium	High
Number of farms in cluster	220	144	38
Area of operation (ha)	380	319	257
Wheat yield			
Mean (tonnes per ha)	1.43	1.93	2.27
Coefficient of variation (%)	26.9	31.7	45.3
Gross agricultural output			
Mean (CAD)	98813	100132	107701
Coefficient of variation (%)	29.4	29.6	36.9

OECD Trade & Agriculture

8

Farm characterization by risk

- Alternatively, farm clustering by key farm characteristics allows the modelling of multiple representative farms.

For example, clustering methods allow 457 Canadian crop farm data to group to 3 clusters by risk characteristics (high, medium, low risk farms)

Risk Cluster	Low	Medium	High
Number of farms in cluster	220	144	38
Area of operation (ha)	380	319	257
Wheat yield			
Mean (tonnes per ha)	1.43	1.93	2.27
Coefficient of variation (%)	26.9	31.7	45.3
Gross agricultural output			
Mean (CAD)	98813	100132	107701
Coefficient of variation (%)	29.4	29.6	38.9

OECD Trade & Agriculture

9

Modelling of multiple representative farms

- Farm clustering allows to simulate differentiated policy impacts by different groups of farm
- This method becomes particularly important to analyze programs based on average index of risk (e.g., area-yield insurance, weather index insurance, disaster payment)
- Such simulation provides inference on which policy benefits what type of farm and support policy making decision

OECD Trade & Agriculture

10

Example: climate change scenario and instruments

Scenarios	Instruments
Baseline without climate change	Individual yield insurance Premium set by farm, 30% deductible and high admin cost (30% of fair premium), subsidy covers 95% of admin cost
Climate change without adaptation Saskatchewan 13 to 24% lower yield, -6 to 10% increase in yield variability	Area-yield insurance Premium set by systemic yield, no deductible and low admin cost (10% of fair premium), subsidy covers 95% of admin cost
Climate change adaptation: 12% increase in yield level	Weather index insurance Premium set by systemic precipitation, no deductible and low admin cost (5% of fair premium), subsidy covers 95% of admin cost
	Disaster ex-post payment Triggers by systemic yield shock, no premium, fixed payment

Differentiated policy impacts by farm

- First- and second-best policy instruments according to budgetary cost-effectiveness in Saskatchewan

	Baseline	Climate Change (CC)	CC with adaptation
Medium risk farm	Weather***	Area***	Area***
High risk Farm	Weather*** Area**	Weather***	Weather***
Low risk farm	Area***	Area*** Weather***	Area***
Weighted average across farm types	Area*** Weather**	Area***	Area***

Tailoring policies

- There is no clear “winner” across scenarios and farm types
- Government could decide to tailor policy instruments to different group of farm
- Government can decide on a single instrument but it involves tradeoffs
- What would be the policy decision making criteria?

Conclusions

- Farm-level analysis is becoming increasingly important for policy analysis
- Policy simulation can be conducted to all farms in survey data, but presentation of results need some aggregation
- **Farm clustering** is an alternative method that allows to model multiple representative farms
- The different farm characteristics can lead to **different results in terms of preferred policy instruments** by different group of farm

OECD Trade and Agriculture



www.oecd.org/agriculture

Contact

shingo.kimura@oecd.org

4 Productivity development of Finnish agricultural sector based on FADN data

Jyri Järvinen and Olli Rantala

4.1 Introduction

Productivity is an important factor for the sustainability and competitiveness in agricultural sector as it is in all other sectors in the economy. Along with both product and input prices and subsidies productivity affects crucially on the profitability and viability of farm enterprises and thus on the whole sector. An increase in productivity creates positive effects to the sector and enterprises. Productivity primarily indicates how effective the production is in transforming inputs into products and services. Productivity can be measured in physical or economical terms on different levels of the economy.

Traditionally productivity measures in Finnish agriculture have been calculated in the whole sector from total calculations of agriculture and horticulture. Results from these studies have been occasionally published by e.g. MTT economic Research and Statistics Finland. Productivity development based on micro data has been examined occasionally in few studies during past years. In calculating the indices the inputs and outputs have been usually aggregated into a few baskets with corresponding prices. These studies give information about the productivity development e.g. in different production types which may differ greatly.

The Finnish profitability bookkeeping/FADN -data provides a good source of micro data for calculating farm level productivity indicators. The breakdown of inputs and outputs are very detailed including around 90 items in both of those. The farm level data have also been carefully checked to eliminate data errors. The bookkeeping data is accrual based so that all costs and returns relate to the same accounting year that is the year of the production. In this paper the application and method with some preliminary results of productivity indicators are presented. Besides several other economic indicators the productivity indicators are intended to be presented in MTT's Economydoctor website.

4.2 Productivity trend in Finnish agriculture

The dominating trend in Finnish agriculture has been quite stable production volume and decreasing use of inputs mainly because of the reduction in labour input. As defined on the basis of the total calculation of agriculture and using Divisia index method the average productivity growth was 1.2 % per year in the period from 1992 to 2010. The same volume of output was reached for around 81 % lower use of input than in 1992. The total output was 96% and use of inputs 78 % of the levels in 1992. The productivity of labour has increased rapidly in the past 15 years, by the average of about 5 % per year. In 2010 the output volume per unit of labour was 2.3 times that in 1992. Total labour input decreased from 160,000 to about 70,000 AWU that is 56 %. In the long run there have not been major changes in the productivity of capital.

As defined on the basis of bookkeeping data the productivity of animal farms has been an average positive during the EU-period. Investment subsidies have encouraged to rapid structural change and to introduce new technology in the livestock sector. In crop farms the productivity was quite low especially in the 1990's but has increased in recent years. For crop farms there are not as much incentives to increase productivity than for animal farms. In crop production the productivity quite clearly follows the trend of yields.

According to research the level of productivity in Finnish agriculture is lower than in main agricultural countries in the EU, mainly because of unfavorable natural and structural factors. In milk production in

farms with the same size the difference to Denmark is 20-30 % which means that by using the same inputs Finnish farms get only 70-80 % of the output what is gained on Danish farms. The productivity difference to Southern Sweden is about 10-20 %.

4.3 Calculation procedure

Productivity means the ratio of between the volume produced and the use of inputs. In aggregation of outputs and inputs the quantity indices are usually calculated using the Divisia index method and thus the change in the output - input index-ratio indicates the development of productivity. The change of total productivity from year t-1 to t can be expressed as:

$$TFP_{t,t-1} = \frac{\text{Output Index}_{t,t-1}}{\text{Input Index}_{t,t-1}}$$

The Divisia input index for the change from year t-1 to t is generally expressed as:

$$\ln \frac{TFP_t}{TFP_{t-1}} = 1/2 \sum (r_{i,t} + r_{i,t-1}) \ln \left(\frac{Y_{i,t}}{Y_{i,t-1}} \right) - 1/2 \sum (s_{j,t} + s_{j,t-1}) \ln \left(\frac{X_{j,t}}{X_{j,t-1}} \right)$$

In the above formula Y_i is the output i and X_j is the input j , r_i and s_j are the corresponding shares of Y_i and X_j of the total revenues and production costs. First part of the right hand side shows the sum, over all outputs, of the logarithms of the ratios of output change between two successive years, weighted by the average shares in total revenues and costs. The latter part of the right hand side relates similarly to the inputs.

4.4 Data and prices

In the application the number of products is in total 88 and that of inputs 91. Besides physical products and inputs they include items like e.g. services, wages, rents etc. Returns and costs of output and input items have been divided by specific price indices in calculating the quantities. As the main source for prices are used the indices of producer prices and that of the production inputs, which are compiled by Statistics Finland and TIKE (Information Center of MAF). For certain items e.g. horticultural products, energy, wage claim etc., also other valid sources of prices are used. In calculating productivity measures to forecast years, prices are estimated by using e.g. regression models like for cereals or some other valid forecast methods. The calculation procedure runs within an application written in SAS code.

4.5 Farm level indices and group averages

The application calculates basically farm level productivity indicators. Productivity indices of a farm give clear information of changes between years and, what is usually more interesting to the farmer of the productivity changes in the long run. The structure of output and input may change a lot over years because of technology and price changes. In calculation group averages in a certain year over farms input quantities of farms are used as weights. Thus bigger farm get a bigger weight in calculation the averages. In calculating indices for a group of farms for a certain period of years, there are alternative methods how to calculate the group averages. Thus far they have been calculated as straight averages yearly over farms, but also some kind of smoothing or sliding counting methods have been examined.

Figure 4.1 Productivity indices (provisional) in 2001-2009 in different production type of farms

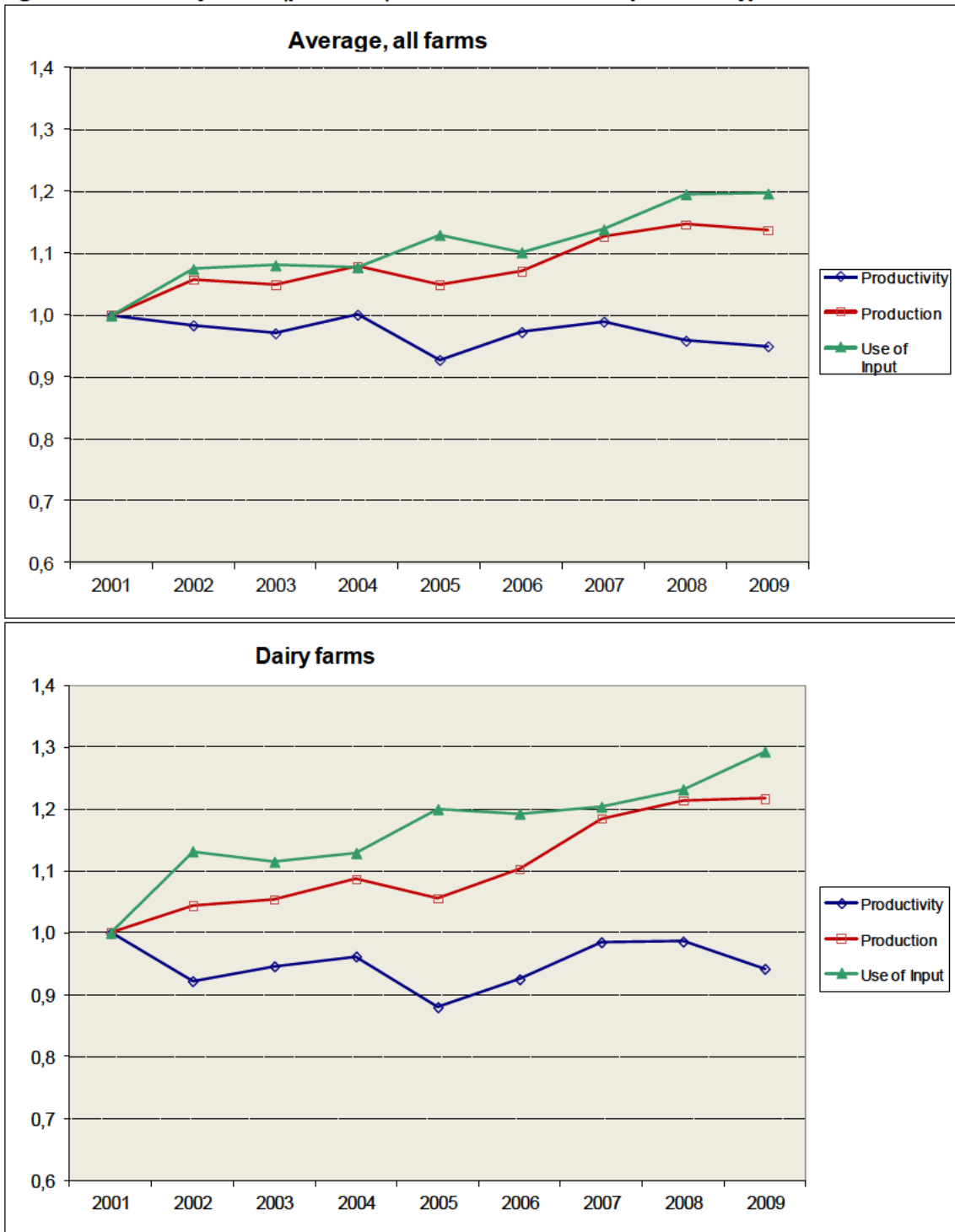
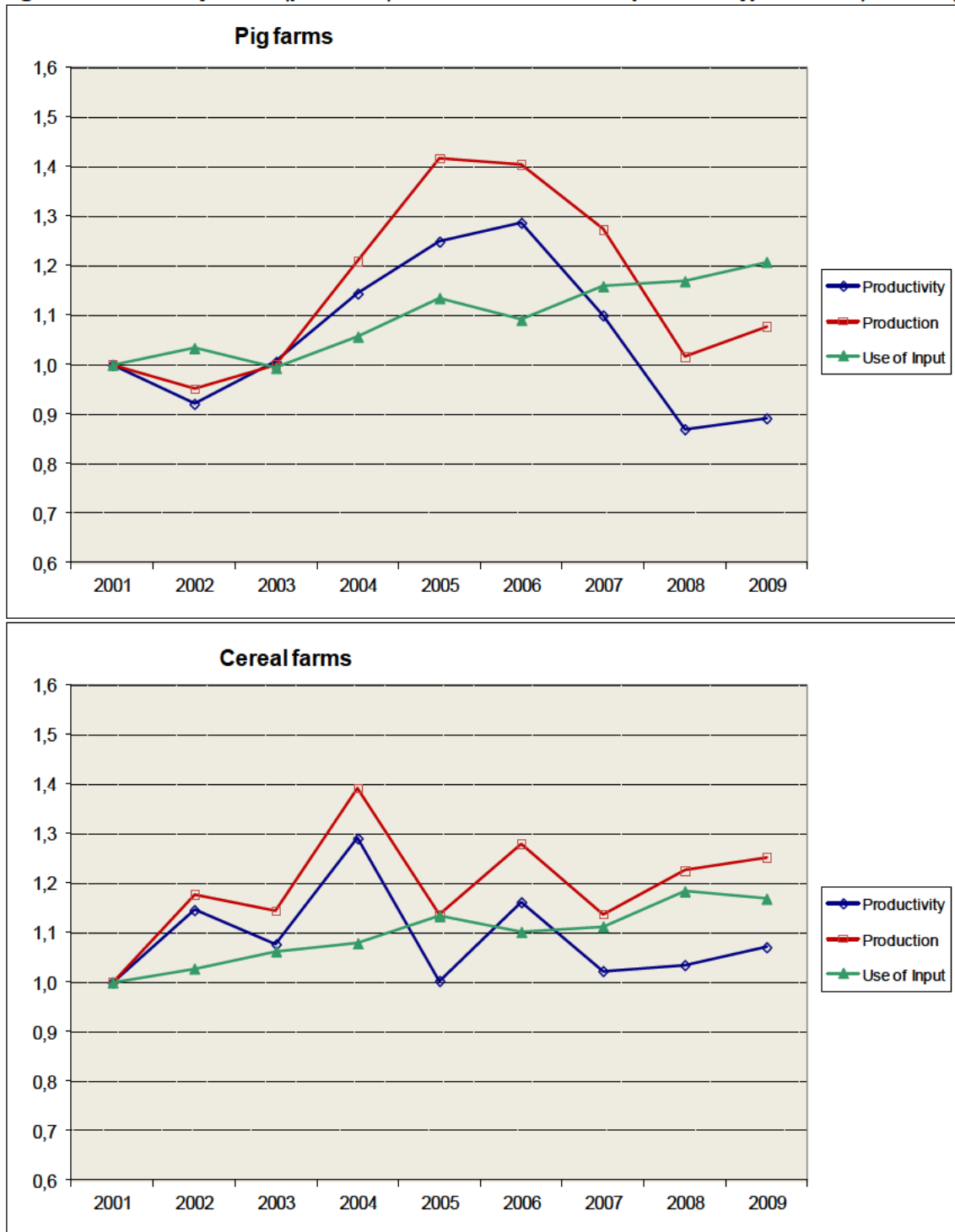

Figure 4.1 Productivity indices (provisional) in 2001-2009 in different production type of farms (continued)



4.6 Reporting of results

The productivity calculation is planned to be launched as a new service in the MTT's Economy doctor web-site. In a tailored interface the user can select as the first classifier period of years and then any from 12 additional classifiers. Those encompass production types, size classes, production methods and several region breakdowns.

After selections have been done the productivity calculation runs as an internal application and the results are then shown in the browser. In current version the results consist of both output and input indices and the productivity indices for selected years, where the first year of the selected period is the base year and the index is denoted as 1.00. Like all group averages in the reporting system of Economy doctor also productivity indicators are presented as weighted averages, so that the results represent average Finnish farms of the respective group.

Figure 4.2 User interface to the productivity service in MTT's Economy doctor website

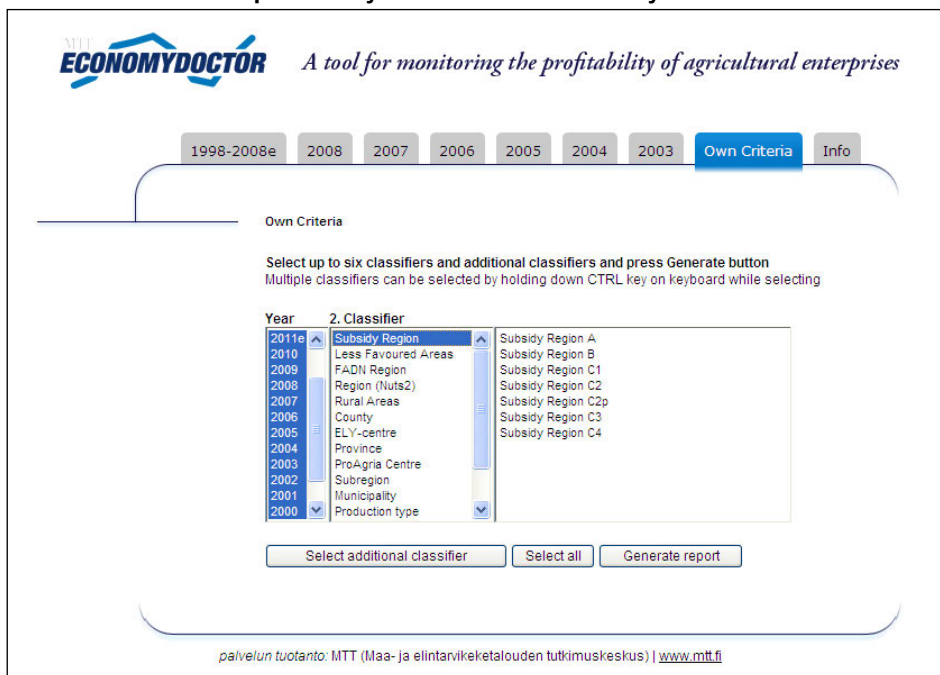

Table 4.1 An example of results (the output to the browser) of productivity service in the Economy doctor

Productivity	2001	2002	2003	2004	2005	2006	2007	2008	2009
Farms represented	48 400	48 200	46 800	45 900	44 300	42 800	40 800	39 600	38 000
Farms in sample	830<n<840	810<n<820	810<n<820	850<n<860	890<n<900	910<n<920	930<n<940	920<n<930	930<n<940
Arable land
Livestock Units
Productivity	1	1,097	0,984	1,145	0,964	1,059	1,048	1,071	1,031
Production	1	1,186	1,044	1,168	1,061	1,136	1,141	1,194	1,156
Use of Input	1	1,081	1,061	1,020	1,101	1,073	1,088	1,115	1,122

4.7 References

Coelli, T., D. Prasada Rao, C. O'Donnell and G. Battese, *An introduction to efficiency and productivity analysis*. 353 p. Springer Science+Business Media, 2005.

Myyrä, S., 'Productivity development in Agriculture.' In: *Finnish Agriculture and Rural Industries* (2011), p. 62-63.

5 Analysis of production costs of milk - a comparison of economic estimates versus allocation schemes

Werner Kleinhanss

5.1 Introduction

Cost estimates of milk production in the EU is of interest for milk market policy analysis in general and also for farm extension work. Milk market policy analysis was mainly based on econometric estimates (Witzke et al., 2009). Results often vary based on the methods applied. Data used for extension work were mainly collected in specialized farms (i.e. Hemme and Otte, 2010; Deblitz et al., 2009), and completed by cost allocation procedures to redistribute non specific and fixed costs to the dairy branch.

In the FACEPA project, two econometric methods have been further developed, tested and applied (Kleinhanss, 2011; Frahan et al., 2011). The first goes in the direction of a whole farm approach, where costs of different cost categories are allocated to individual farm outputs (products). This is done by the estimation of input-output coefficients based on seemingly unrelated regression. The second approach 'Estimation of McFadden cost functions' estimates non-linear cost functions which can be used for the simulation of policy measures (Frahan et al., 2011).

This paper deals with the estimation of input-output coefficients and derived costs and incomes. They are compared with costs computed by a cost allocation procedure, where costs are allocated based on shares of the milk branch on livestock, land use and output. In a further step, the latter approach is extended to compute aggregated cost functions of the national or the EU dairy sectors.

5.2 Method and data

Two methods are used for the empirical work: a) the GECOM model for the estimation of input-output coefficients and derived costs and incomes; b) the cost allocation approach. Both methods are described briefly below.

5.2.1 The GECOM model

The econometric model aims at the estimation of input-output coefficients based on farm accounting data of EU- or national FADNs. The principles were developed by Pollet, Butault and Chantry (2001) and Pingault and Desbois (2003). Within the FACEPA project, the method was further developed, tested in countries of project partners and applied using improved and the more user-friendly software packages developed in the project. The specification of the econometric model¹ is as follows:

$$x_{if} = \sum_{k=1}^K \beta_{ik} y_{kf} + u_{if} \quad [1]$$

¹ Estimates are realised in using the SAS 'PROC SYSLIN' procedure.

Where

- x_{if} total cost of input i of farm f (including income),
 y_{kf} total value of output k produced by farm f ,
 β_{ik} is the unknown coefficient of production; it is defined as the average (for all farms) expenditures on input i required to produce one unit of output value k ,
 u_{if} is the error term specific to each input and farm.

With

$$\sum_{k=1}^K \beta_{ik} = 1$$

The income (indicator) is considered as an input, and (coupled) subsidies are considered as a negative input. Input-output coefficients are generally based on monetary figures, expressing cost shares referring to total output. They are linear-proportional to output and are representing the average shares of the underlying farm sample. Effects of scale, specialization and location can be derived by estimates based on respective sub-samples.

5.2.2 Cost allocation model

The cost allocation model for the dairy branch is based on a simulation model developed in the RICA unit of the EU Commission¹ (European Commission, 2010). The model has been modified and applied to calculate the costs and margins of milk production as well as income shares of the dairy branch. Further, the external data base was extended to the year 2008, and the model has been extended to calculate country or EU wide cost functions.

The allocation of costs to the dairy branch is based on output or livestock shares. The model is applied for specialised dairy farms based on FADN data. Calculations are based on the level of individual farms, but results are aggregated by different criteria, of which only regions,² farm size (expressed by number of dairy cows) are used in this paper.

The cost items of the different cost categories were harmonised for both models. As costs of hired labour were excluded in the GECOM model they were excluded in the 'allocation scheme', too. For the latter, opportunity costs for farm-owned factors are computed allowing total cost calculation. Although costs were rather disaggregated in both models, they were aggregated in the following graphs as mentioned in Table 5.1; the referring income indicators are also mentioned in this table (Table 5.1).

¹ EU-FADN DG AGRI L-3; DG AGRI model for the allocation of costs for milk

² Regions in Member States beside Germany were defined referring to main production regions; the remaining region of a country are aggregated to 'others' (see Annex 1).

Table 5.1 Output and coupled subsidies

Output + coupled subsidies	
- Operating costs	(Specific + non specific costs)
- Depreciation, wages, interest	
➔ Margin	
- External factors	
➔ Net margin	
- Imputed costs own factors	
➔ Margin over total costs	

The calculations are based on EU FADN data of the years 2003¹ to 2008. As the econometric estimates are sensitive to extreme values, observations with outlying data were cancelled in applying an outlier procedure developed in the FACEPA project (Bahta et al., 2011). In the next step samples of rather specialised farms² were selected. Although the same selection criteria was used, the number of observations used in both models deviated, because plausibility checks within the models were not completely harmonised (see 5.10 Appendix 5.2). Deviations in the results might therefore be slightly influenced by the varying number of observations. Due to time constraints it was not possible to adjust and to rerun the models again. Therefore, the focus of this analysis is to test if the methods come out with similar results or not. Another aspect is to compute cost functions.

5.3 Costs for selected EU countries based on estimates or allocation schemes

The analysis focuses on the following EU Member States: Germany, France; Italy; United Kingdom, Netherlands and Poland. Regional differentiation is made referring to concentration of production; where the remaining areas are summarized in the group 'Other'.

5.3.1 Structure and development of costs and margins

Results for **Germany**³ are shown in Figure 5.1, based on econometric estimates at the bottom and on the cost allocation scheme on the top. They are differentiated into 4 regions: 1: the 3 Laender of north; 2: the centre and south-west, 3: Bavaria and 4: the eastern Laender. There is no differentiation by farm size, but by years, where 2003 to 2005 are aggregated due to rather similar economic framework conditions.

¹ Data of the years 2003 to 2005 are aggregated into one period.

² Farms are selected based on FADN farm typology TF8: 41 (Specialist dairying), 43 (Cattle-dairying, rearing and fattening combined), 71 (Mixed livestock, mainly grazing livestock), 81 (Field crops-grazing livestock combined).

³ Regions Germany: (1): Schleswig-Holstein, Lower Saxony, North Rhine Westfalia; (2): Hesse, Rhineland Palatinate, Saarland, Baden-Württemberg; (3): Bavaria; (4) other areas.

Figure 5.1 Structure of production costs of milk - Germany

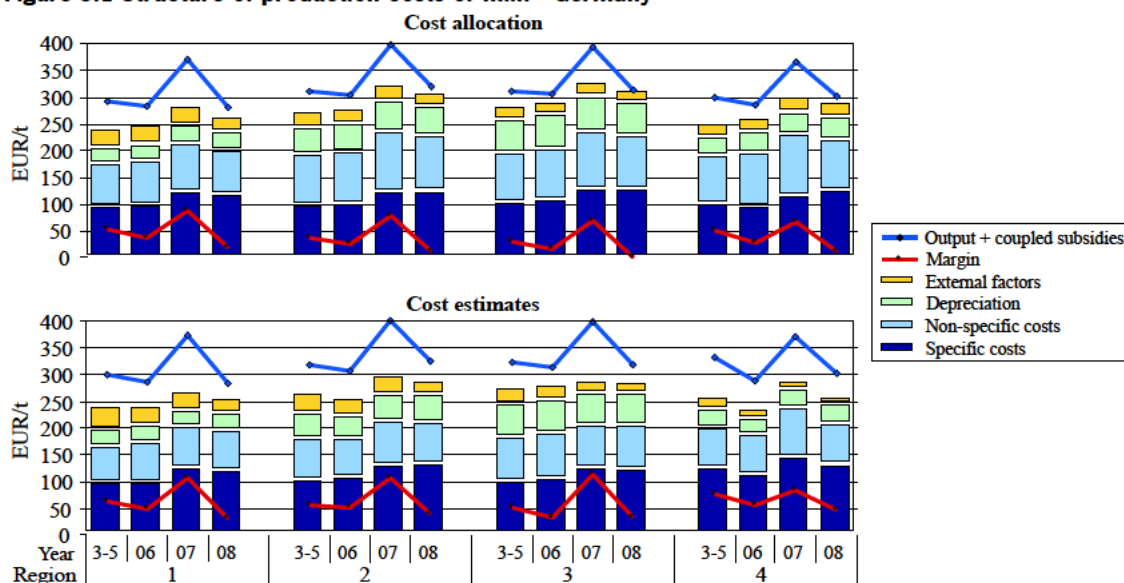

Source: EU_FADN-DG AGRIL-3; DG AGR model for the allocation of costs for milk; FACEPA.

Estimates of specific costs per ton of milk are rather similar (100 €/t) for the years 2003 to 2006 in Regions 1 to 3. In 2007 they increased to 120 to 130 €/t due to rising costs of concentrated feed and fertilizer and stayed at this level also in 2008. Specific costs are slightly higher in Region 4, which might be related to the higher share of concentrated feed or purchased roughage feed. Non-specific costs are about 70 to 80 €/t; they also increased from 2007 onwards due to rising energy and fuel prices. Depreciation is about 30 to 40 €/t in regions with larger sized farms (Regions 1 and 4) and about 50 to 60 €/t in Regions 2 and 3 with smaller farms. Costs of external factors include interest of lent capital and land rentals; referring to definitions in the GECOM model, they do not include labour costs of hired workers. External factor costs are about 30 to 40 €/t in Regions 1 and 2, slightly lower in Region 3, and less in the Eastern region due to lower land rental prices. The total of these cost items were lowest in the North and East (240 €/t) in 2003 to 2006. They increased by about 30 €/t from 2007 onwards. While costs were highest but rather stable in Bavaria (Region 3) they amount to 300 €/t in Region 2. Output declined from 2003 to 2006 due to lower milk prices and the decoupling of direct payments. It increased by one third in 2008 due to booming milk prices and dropped to post-2007 levels in 2008.

Results of **the allocation scheme** are shown at the top of Figure 5.1. The level and development of specific cost in Regions 1 to 3 is similar to the estimates, while in region east they are lower. Non-specific costs are, with 70 to 100 €/t, higher than estimates. Depreciation and costs of external factors are comparable. The level of total costs considered is insignificantly higher in Regions 1 and 2, and the cost development in time is similar. In Bavaria the allocation approach results in the higher cost, especially in the years 2007 and 2008. Compared to the larger variation in time of the estimates in Region 4, the allocation scheme shows a similar cost development to the other regions. Costs were lowest in the North, the East took second place, and costs were highest in Bavaria.

With regard to economic performance, returns and margins have to be considered simultaneously. Output showed a strong increase in 2007 due to rising milk prices and it was slightly above average in Regions 2 and 3. Referring to estimates, margins were about 50 €/t in Regions 1 to 3 in the years 2003 to 2006; they doubled in 2007 and dropped to about 40 €/t in 2008. Margins were more stable in Region 4. Based on the allocation scheme, margins are slightly lower than the estimates, the peak in 2007 is less expressed and in 2008 margins tend to zero in all regions.

Although the results look quite similar, there are some differences depending on the methods (Figure 5.2). Output is slightly higher by the estimates in the first period; this might be due to assumptions

which probably differ on the allocation and specification of coupled subsidies. However, the difference of 30 €/t in Region 4 seems to be high and requires a check of the data. On the other hand, the estimated total of considered costs is generally lower, with the exception of Region 4 in the first period. Costs are about 20 €/t lower in Region 2 and about 30 to 40 €/t in Region 3 in 2007 and 2008. The resulting margins are generally higher in the estimates (about 10 to 20 €/t up to 40 €/t in 2007).

Although the case of Germany indicates lower costs and higher margins of the estimates, it is difficult to conclude that costs are underestimated and margins overestimated by the econometric model.

Figure 5.2 Deviation of estimates versus allocation - Germany

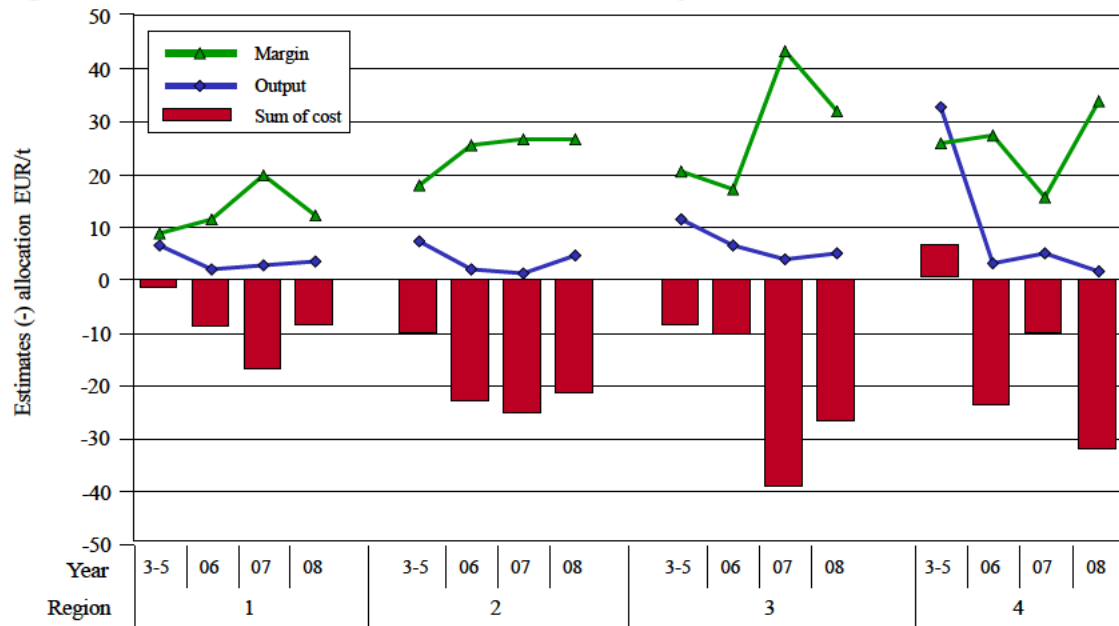

Source: EU_FADN-DG AGRIL-3; DG AGR model for the allocation of costs for milk; FACEPA.

Results for France¹ are shown in Figure 5.3. Costs, output and margins are similar in the estimates and the allocation scheme for Regions 1 and 3. Compared to Germany there is a steady increase of costs over time, mainly driven by specific costs. Margins in Region 1, which is the most important area of milk production in France, are about 50 €/t, which is comparable to the region North of Germany. However, compared to the latter, there is lower variation in time.² Margins in Region 3 are on a similar level only in 2003 to 2005, while they dropped close to zero in 2006 and 2007 based on both the estimates and the allocation scheme. In the case of Region 2, the methods come out with different results. Costs were lower and outputs higher in the estimates. While margins derived by the estimates vary from 30 to 90 €/t, they were close to zero in the allocation scheme in 2006 onwards. Especially the margins are considerably higher in the estimates in 2008 (+75 €/t).

¹ Regions France: (1): Basse Normandie, Pays de la Loire, Bretagne; (2): Franche-Compte; (3) other areas.

² Data refer to calendar years, while in Germany they refer to economic years, where 2008 includes the second half of 2008 and the first half of 2009. Therefore the price development in France is delayed by a half year compared to Germany.

Figure 5.3 Structure of production cost of milk - France

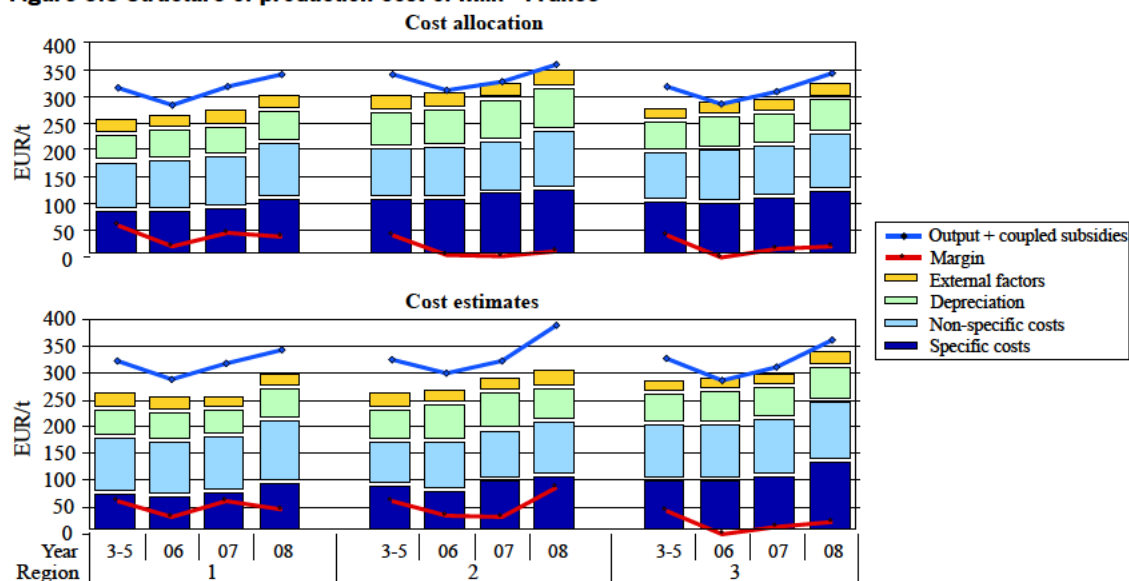

Source: EU_FADN-DG AGRIL-3; DG AGR model for the allocation of costs for milk; FACEPA.

Results for the **United Kingdom**¹ are given in Figure 5.4. Referring to the cost structure specific costs are higher and rising more than in Germany and France, but non-specific costs and depreciation were lower. Costs were rising until 2007 and rather stable in 2008. The output level is lower than in Germany. Margins derived by the estimates were highest in Regions 1 and 2 and lowest in Region 3. They were lowest in 2006 and rising till 2007 and 2008. Margins by the allocation scheme are higher in most cases, especially in Region 3 with about 25 €/t.

Figure 5.4 Structure of production costs of milk - United Kingdom

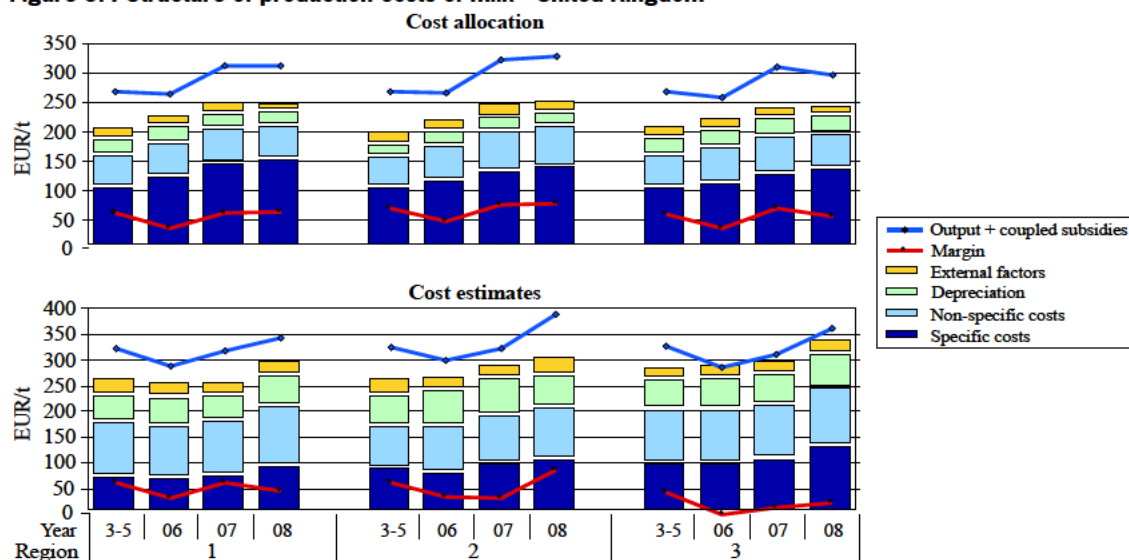

Source: EU_FADN-DG AGRIL-3; DG AGR model for the allocation of costs for milk; FACEPA.

¹ Regions United Kingdom: (1): England-North; (2): England-West; (3) other areas.

5.4 Comparison of costs and margins derived by estimates and the allocation scheme

Results of both methods are shown for six EU Member States for two items, the total of considered costs and the margins.

- In the case of **Germany** (Figure 5.5) estimated costs are slightly lower than those derived from the allocation scheme, and therefore margins are higher in the estimates. While estimates indicate margins of 30 to 50 €/t in 2008, they approached zero by the allocation scheme.
- In **France** costs by both methods are close in two regions, as are the margins. In Region 2 costs are significantly lower in the estimates, resulting in margins of about 50 €/t based on estimates, while they are close to zero from 2006 onwards.
- Total costs in **Italy** are slightly lower than in France and Germany. Estimates are generally higher than by the allocation scheme. As output is considerably higher than in other countries, high margins of 100 to 150 €/t remain. Margins in the estimates are about 50 €/t lower in Region 1, which is the most important region of milk production in Italy. They are almost similar in Region 3 and for the first three periods in Region 2.¹

Figure 5.5 Comparison of costs allocation/estimates

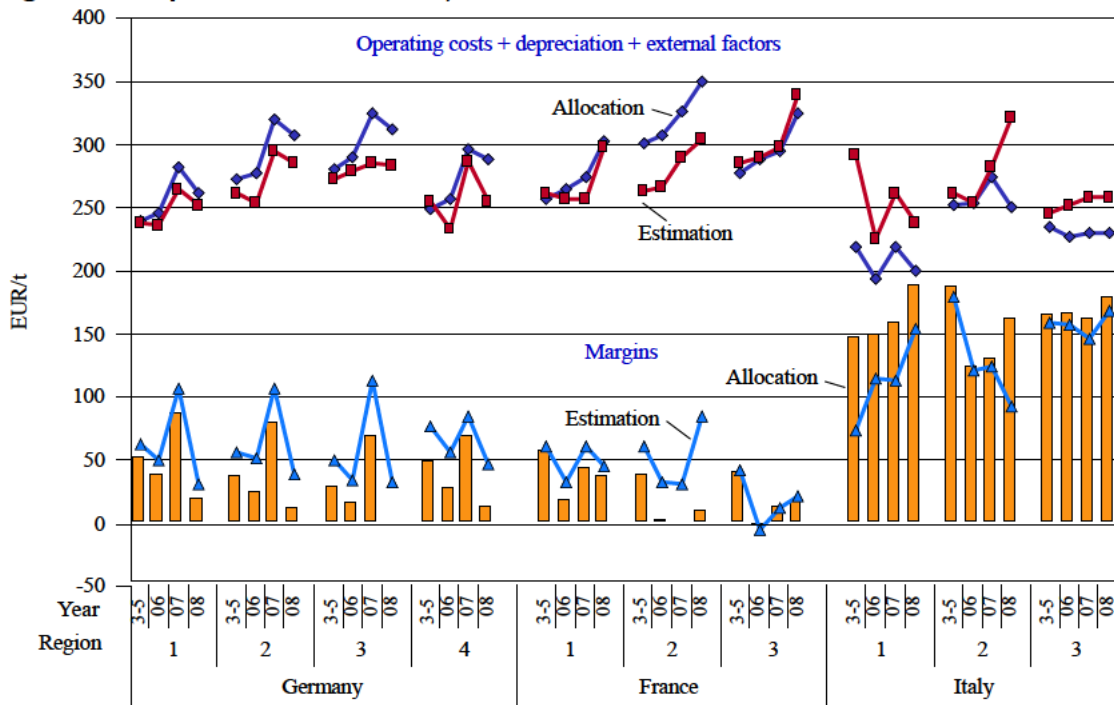

Source: EU_FADN-DG AGRI L-3; DG AGRI model for the allocation of costs for milk; FACEPA.

- In the **United Kingdom** (see Figure 5.6) costs are slightly or significantly (Region 3) higher by the estimates. This results in lower margins in Region 2. It has to be mentioned that margins vary less than in other countries but on average they are close to Germany.
- In the **Netherlands**² total costs were rising, especially in 2008. However they are close to each other by both methods. Margins were about 70 €/t until 2007 and dropped to 40-50 €/t in 2008. With one exception, margins derived from estimates are a little bit lower than by the allocation scheme.

¹ Region Italy: (1) Lombardia; (2) Emilia-Romagna; (3) other areas.

² Regions for the Netherlands: (1) Groningen, Friesland and Drenthe; (2) other areas.

- Costs in **Poland** were only 150 €/t in the first period and therefore about 100 €/t less than in other countries. They increased considerably until 2008 to around 200 €/t. Cost estimates are about 20 to 30 €/t less than by the other method, resulting in higher margins of around 80 to 100 €/t based on estimates. Margins are higher in Region 1 (Podlaskie), with the highest concentration of milk production in this country.

Figure 5.6 Comparison of costs allocation/estimates

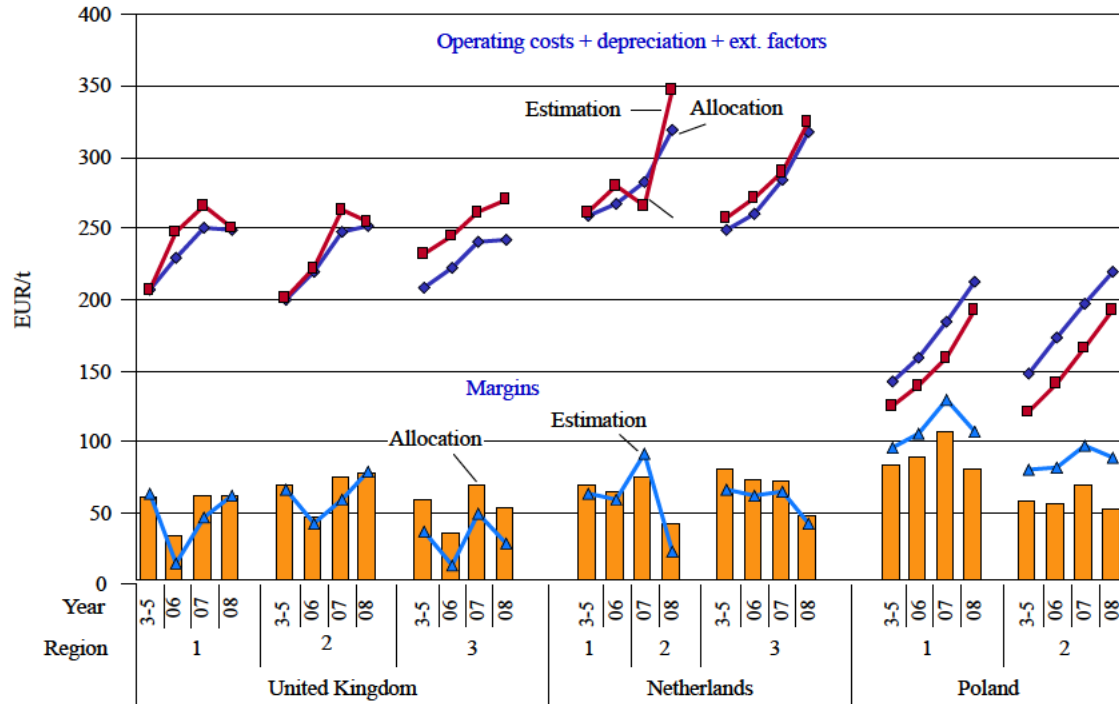

Source: EU_FADN-DG AGRI L-3; DG AGRI model for the allocation of costs for milk; FACEPA.

5.5 Extending the approach towards full costs

While the econometric model has some weakness in estimating other fixed costs as well as opportunity costs of farm owned factors, the method is not appropriate for full cost analysis. The latter can be approached by the cost allocation model. Results are only shown for Germany. Figure 5.7 shows costs of 3 cost aggregates by regions and years. The left columns refer to aggregates shown before (operating costs, depreciation and of external factors, excepting wages). The consideration of wages doesn't change the cost levels at all in western Germany, due to the dominance of family labour input. But this cost category induces an increase of costs of about 50 €/t in Region 4 (East) with high shares of salaried labour. The remuneration of farm owned factors (own capital, land and family labour) amounts to about 50 €/t higher costs in western Germany, but of only 20 €/t in the East. Referring to full costs it can be concluded that they are lowest in the North, whilst region East becomes less favourable than when referring to partial costs.

Figure 5.7 Milk production costs (diff. elements) - Germany >50 cows

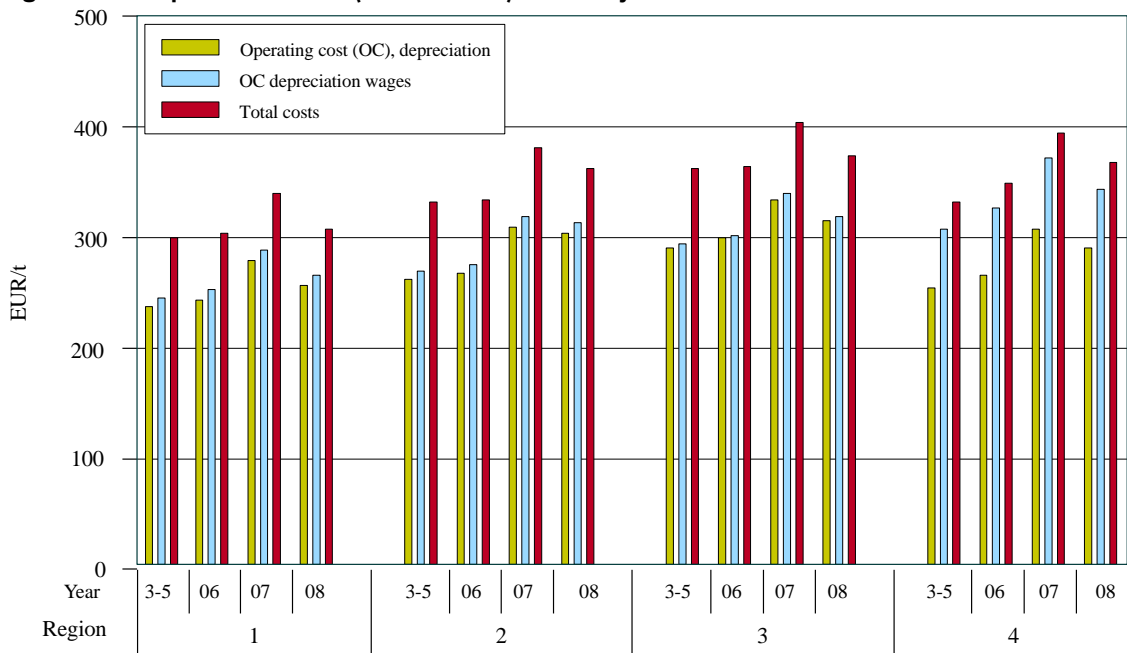

Source: EU_FADN-DG AGRI L-3; DG AGRI model for the allocation of costs for milk; FACEPA.

The analysis of performance should include outputs and derived income indicators. This is shown in Figure 5.8, taking farm sizes into account. Whilst small farms (<50 dairy cows) show almost positive margins in western regions, they become negative in region East under consideration of wages. Margins over total costs become largely negative (from -40 to -120 €/t in the western regions and of about -120 to -170 €/t in the eastern regions). Margins are higher in larger farms (>50 cows). In western regions they are positive and up to 90 €/t. Even with full costs they became positive in 2007 in Regions 1 and 2, whilst they were slightly negative in the other years. Margins over full costs are about -50 €/t in Bavaria as well as region East, which means that economic performance is quite similar despite the duality of the farm structure. The overall conclusion is that milk production in region North has lower costs and higher margins compared to the other German regions. The main driving factors are the dominance of larger farms, high milk yields and lower opportunity costs of family labour. On the other hand it has to be mentioned that full costs can hardly be fully covered under 'normal milk price conditions', while this was possible for larger farms under the milk price level of 2007.

Figure 5.8 Milk margins over different cost elements - Germany by size of dairy farms

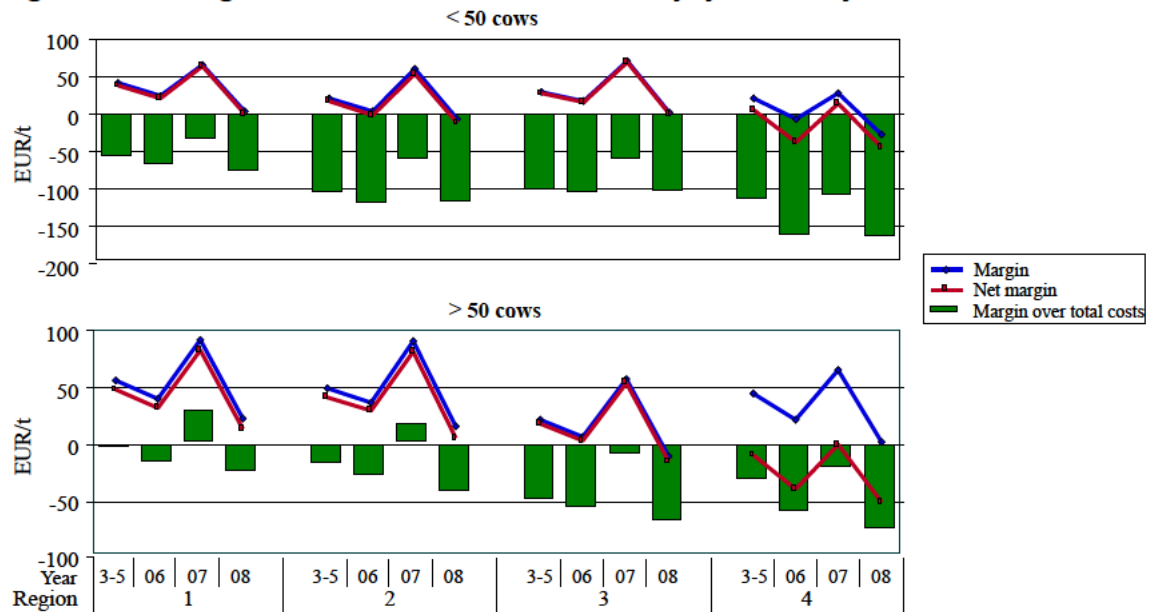

Source: Own calculations based on the cost allocation model.

5.6 Extension towards cost functions

Based on the cost allocation scheme it is also possible to derive cost functions in summing up costs computed at the farm level, weighted by the underlying milk quantity. To get a complete figure at the sector level we include all farms with dairy cows. We used another model version, where also by-product sales of male calves and the referring costs, as well as coupled subsidies for maize forage production, were included. Cost functions are computed by years and refer to different cost aggregates.

Figure 5.9 shows cost functions for Germany referring to the total operating costs, depreciation and costs of external factors (including wages) for the years 2003, 2006 and 2007. There is only an insignificant share of milk produced at low costs up to 150 €/t. In 2003 30 % of milk is produced at costs up to 200 €/t. Another third is produced with costs of 200 to 250 €/t. 90 % of milk is produced at costs up to 300 €/t equal to the market price.

Figure 5.9 Aggregated cost function referring to operating costs, depreciation plus ext. factors - Germany

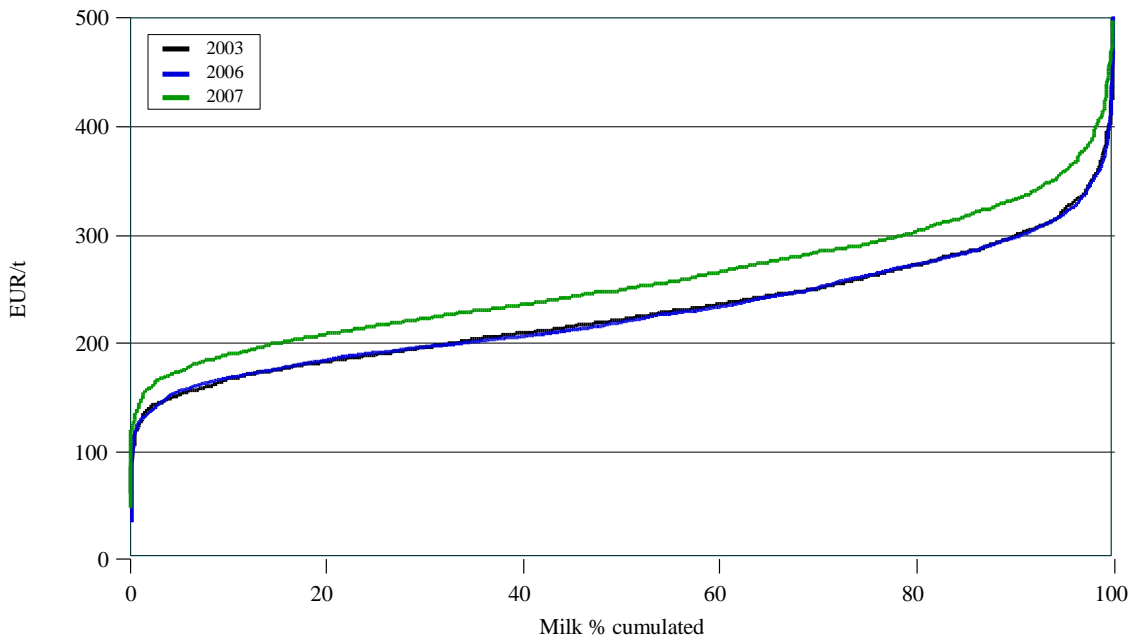

Source: Own calculations based on the cost allocation model.

In 2006 the cost function is almost similar to 2003. Due to increased costs for feed, energy and fertilizers, the cost function for 2007 got a higher slope. This means that only 15 % of milk has been produced at costs up to 200 €/t, 50 % at costs up to 250 €/t and 80 % at costs up to 300 €/t. As milk prices raised to 370 to 400 €/t at that time, less than 5 % of milk produced was non-profitable.

Aggregated cost functions for EU-25 are shown in Figure 5.10, taking 2006 as an average year. The figure on the top refers to the total operating costs, depreciation and costs of external factors, while at the bottom total costs are assumed including opportunity costs for farm owned factors. In addition the referring milk prices as well as milk price and by-product returns are shown, which allows to calculate shares of milk production being competitive or not.

Figure 5.10 Aggregated cost functions - EU-25 (2006)

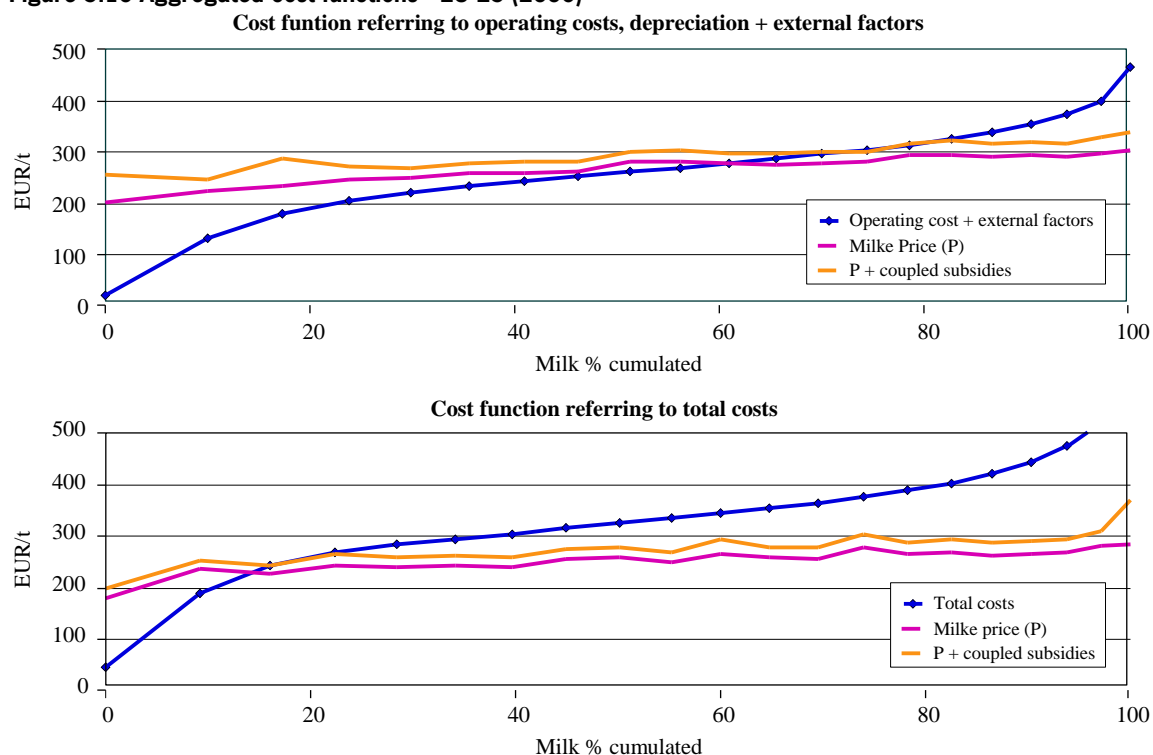

Source: Own calculations based on the cost allocation model.

The cost function shows extremely low costs for about 5 % of production. Part of these low costs might be related to the data. Referring to partial costs (top figure), one quarter of the milk is produced at costs up to 200 €/t and 60 % at costs up to 280 €/t. This is also the equilibrium with the milk price. Including by-products, 80 % of milk is produced at equilibrium returns. For another 20 % of milk, costs are higher than returns, and therefore production is not profitable.

Referring to total costs (including opportunity costs of owned factors), the situation becomes much worse. For only 20 % of milk production costs are lower than milk returns. Including by-products, the share is only 25 %. This means that for about half of milk production the farm-owned factors are only partly remunerated. For another 20 %, returns wouldn't even cover part of depreciation and / or costs of external factors.

5.7 Conclusions

The analysis of production costs in the dairy sector is of importance with regard to policy and farm decision making. The aim of this paper is to compare two methods of cost calculation, an econometric method of estimating input-output coefficients developed in the FACEP project, and an allocation scheme developed in the RICA unit of the EU Commission. Although the definition of cost items and selection of samples was harmonised, the number of observations was not entirely identical due to model-internal plausibility checks of the data. The models work on different principles: in the econometric model all cost items are endogenously allocated referring to the monetary output, while in the allocation scheme the main part of specific costs is related to shares of dairy cows on total livestock, while other costs are allocated based on milk share on total output. Due to these concepts, the results give only indicative figures. For a large part of aggregates (countries, years, regions) results are close to each other but not identical. The econometric model gives slightly lower costs and higher margins than the allocation scheme. However, it is hard to prove which model is the best one.

One limitation of the econometric model is the restricted possibilities of differentiation i.e., by farm sizes. In the case of few observations the estimates are sometimes unreliable. In contrast, the allocation scheme could be differentiated up to a handful of farms. Therefore the effect of different criteria on production costs could be easily analysed. The model can easily be extended to derive cost functions at the sector or EU-wide level as shown in this paper. Thus the shares of milk production which are or are not competitive can be quantified.

5.8 References

- Bahta, S., W. Kleinhanss and A. Berner, 'Results for Germany.' In: Kleinhanss, W. (ed.), *Implementation, validation and results of the cost of production model using the EU FADN*. FACEPA Deliverable No. 3.2, 2011. <www2.ekon.slu.se/facepa/documents/Deliverable_D3-2_vT1.pdf>
- Deblitz, C., Y. Zimmer, B. Lassen and W. Dirksmeyer, *Participation in EDF. Cost of production comparison 2009*. 2009. <<http://www.agribenchmark.org/fileadmin/freefiles/ab-glance-1012.pdf>>
- European commission, *EU Dairy Farm Report*. 2010. <http://ec.europa.eu/agriculture/rica/pdf/dairy_report_2010.pdf>
- Frahan, H.B., A. Baudry, R. de Blander, P. Polome and R. Howitt, 'Dairy farms without quotas in Belgium: estimations and simulations with a flexible cost function.' In: *European review of agricultural economics* 38 (2011) 4.
- Hemm, T. and J. Otte (eds.), *Status and prospects of smallholder milk production - A global perspective*. FAO, Rome, 2010. <<http://www.fao.org/docrep/012/i1522e/i1522e00.pdf>>
- Pingault, N. and D. Desbois, *Estimation de couts de productions des principaux produits agricoles a partir du Rica*. Ministère de l'Agriculture, de l'Alimentation de la Pêche et des Affaires Rurales. Notes et Etudes Economiques, no. 19, december 2003, pp. 9-51.
- Pollet, P., J.P. Butault and E. Chantry, *The Agricultural Cost Model*. Agricultural Division, INSEE, ESTAT-2001-03195-00-00-EN-TRA-00-FR, 2001.
- Witzke, P. et al., *Regional economic analysis of milk quota reform in the EU*. European Commission, JRC-IPTS, 2009. <<http://ftp.jrc.es/EURdoc/JRC53116.pdf>>

5.9 Appendix 5.1 Aggregation of regions

Country	Variable	Region			
		1	2	3	4
Germany	A1	Schleswig-Holstein Niedersachsen, Nordrhein-Westfalen	Hessen Rheinland-Pfalz Saarland, Baden-Württemberg	Bayern	
France	NUTS2	Basse Normandie, Pays de la Loire Bretagne	Franche-Comé		
Italy	NUTS2	Lombardia	Emilia-Romagna		
United Kingdom	A1	England-North	England-West		
Netherlands	NUTS2	Groninen, Friesland, Drenthe			
Poland	NUTS2	Podlaskie			

Source: Own calculations based on the cost allocation model.

5.10 Appendix 5.2 Number of observations in samples

	Region	Germany		France		Italy		United Kingdom		Netherlands		Poland	
		Estim.	Alloc.	Estim.	Alloc.	Estim.	Alloc.	Estim.	Alloc.	Estim.	Alloc.	Estim.	Alloc.
2003-5	1	2,264	2,405	1,716	1,820	608	585	320	336	203	240	1,221	1,284
	2	1,880	1,989	416	501	699	594	430	464	669	830	6,140	6,406
	3	1,715	1,951	2,999	3,315	3,734	2,727	1,233	1,263				
	4	1,304	1,587										
2006	1	637	717	471	501	242	236	95	99	64	77	617	631
	2	617	647	126	157	210	185	124	135	249	281	2,915	3,048
	3	574	670	974	1,109	1,286	944	353	360				
	4	410	526										
2007	1	654	695	466	495	228	235	85	90	75	82	621	625
	2	626	621	128	151	185	195	128	137	226	263	2,969	3,051
	3	561	628	1,028	1,138	1,281	1,055	343	354				
	4	433	545										
2008	1	698	686	452	446	173	155	96	96	71	67	601	582
	2	611	562	132	130	209	173	138	135	223	219	3,098	2,817
	3	530	508	1,032	1,007	990	691	317	312				
	4	448	434										
Total		13,962	15,171	9,940	10,770	9,845	7,775	3,662	3,781	1,780	2,059	18,182	18,444

Source: Own calculations based on the cost allocation model.

6 The value of land according to data from the Italian FADN

Concetta Cardillo, Massimo Gioia and Franco Mari

6.1 Introduction

Land is the most important productive factor for farms, and its limited availability makes it such a precious asset, that the possession of land has become an element of competitiveness among the different production sectors and among the different forms of capital investment (shelter asset). Social aspects linked to land ownership sometimes are also the cause of great tension; the actors involved in agriculture, even if not full-time, and for whom land represents a significant component, are such a large number that the agricultural land market has been a subject of interest in agricultural economics since the origin of the discipline. This interest is also evidenced and documented by INEA, which, for more than half a century - since 1957 precisely - has performed an annual survey of the land market and the rent of farming lands.

The Farm Accountancy Data Network (FADN), carried out by INEA since 1965, is the only EU statistical survey that aim to collect information appropriate for the study of agricultural income production mechanisms, and, more generally, to the study of the economic aspects of farms. To carry out this task, the FADN uses a significant statistical sample of farms, responding to all EU requirements, and collect a large number of technical and economic variables (around 1,200 per farm) which are relevant to the farms and to the productive processes that they carry out, including those normally used to study the characteristics of the agricultural land market. Nevertheless, it seems that nobody has ever attempted to investigate the phenomenon of the agricultural land market using data from the FADN, and this is therefore the objective of this work.

The aim of this research is not to produce new information on the value of agricultural land, but rather to establish a method to analyse and to test FADN information related to them. The study was conducted using data from financial years 2006 and 2007, as in this period INEA adopted a new accounting method through which financial year 2008 was registered, and the panel composed of data from 2007 to 2008 was not deemed in keeping with the objectives of the study. Nevertheless, this inconvenience can be overcome as soon as data relative to financial year 2009 becomes available.

6.2 An outline of the determining forces behind the value of agricultural land

The value of agricultural land has been one of the most studied subjects in the field of estimation for many years, both by various authors and by many intellectuals who still today treat the subject in a very detailed manner (Polelli, Corsi, 2007). Generally the value of land is determined by many factors including economic, political, historical, structural and natural conditions, which often result in a complex evaluation (Swinnen, Vranken, 2007). An approach adopted by many studies on the subject is the socio-economic approach, which links land value not only to developments in the agricultural sector, but also to the economic context as a whole. More recently, studies on the land market have concentrated on a multitude of aspects: relations with the territory, environmental tools and constraints, soil use, urban and territorial planning, cover against inflation (land may be seen as a shelter asset), and others. The factors affecting the land market, as we said above, are thus very disparate across the different countries; in the context of these studies, the main objects of analysis have often been the components of the land market, the determining factors which affect this market, and which often differentiate it from all other sectors. Traditional land market theories consider, for instance, the price of agricultural products as one of the most important factors in

determining the price of land. As a matter of fact, the land output prices can influence the farmers' decision to invest or not in a land purchase; generally the rise of products prices makes the agricultural activity more remunerative, and has a strong influence on the price of land. The situation naturally varies according to the type of product acquired from land, for example crops or livestock. From recent researches, however, it emerges that the effect that the price of agricultural commodities have on the price of land is positive but very weak (Moller et al., 2008). From an economic point of view, the value of land is determined by the matching point between supply and demand. However, it is also important, in determining the price of land, the productivity of land in a determined area, which normally depends on the quality of the soil which is measured in terms of land type. The term type of land refers to the various characteristics attributable to the soil, for example the topographic characteristics as: location, altitude, situation, inclination, exposure; but also physical and chemical characteristics: hydrological, climatic, environmental and structural characteristics (size, conformation, composition, access, internal viability, organisation of land, buildings, irrigation and soils works, plantations, electrical, telephone and gas lines); forms of conduction; territorial plans and constraints: urban planning, countryside planning, national parks. The role played by agricultural productivity as a determining factor on the value of agricultural land is, however, weaker than that played by the price of commodities, and in some countries, it is even inessential and seems to have a greater impact on the land sales market than on land rental market (Swinnen et al., 2008). General agricultural economics policy indications are also important when determining land value, in particular the system of subsidies and contributions for agricultural activities, which may assume the form of tax reliefs, direct payments or subsidised credit.

The common agricultural policy, both in its coupled and decoupled models, has influenced the value of land in Member States but, while for coupled payments the result is in line with land market theory, the relationship between single payments and land value is not, since in this case, market imperfections and transaction costs play an important role. Besides the effects that direct payments can have on income, increasing purchasing capacity and thus the tendency to offer more for land, the introduction of the single payment also has an effect on the land transfer market. The main result stemming from the introduction of the single payment is the segmentation of the market between eligible and ineligible land, thus between land with and without entitlements. These differences seem to be reflected in the value and in the different degree of attractiveness of the land; ineligible land should be less costly, but, of course, the value also depends on the type of land. Furthermore, this difference should disappear in the future as a greater area becomes eligible through single payments. Some experts of the sector believe that the value of land is not affected by decoupling, claiming that for land purchasing decisions, long-term developments, such as cover against economic risks or speculative aspects, are more important than the value of direct payments (Swinnen et al., 2008). In the case of an excess of entitlements of payments, those farmers in possession of payment entitlements greater than the eligible area will be willing to pay higher rental or sales prices for lands in order to activate them. It is thus expected that requests for land to activate entitlements payments will maintain values at a high level. Nevertheless, some experts in this topic argues that, if we compare this with other determining factors, the effect of the single payment on the value of land seems to be weaker. On the other hand, it is believed that the greater effects of the CAP reform, and, in particular, the move to the single payment, can be connected to a reduction in land market activities, due to an increased level of political uncertainty and doubt regarding its future developments, which tend to make farmers more cautious and conservative in purchasing land. It is in fact difficult to estimate the profitability of a land investment in the long term, and therefore, the number of transactions tends to remain stable in the vast majority of cases, as does the value of land. According to some experts, coupled payments that have the ability to influence land value hardly exist today. However, as previously stated, the link between the single payment and the value of land varies according to the different types of farming. In many cases, the effects of the single payment are negligible, titles are connected to the ownership of land and farm strategies are more oriented towards the maintenance of the property and the use of connected activities. Some policies, including those for rural development and for the environment, influence the value of agricultural land only in some EU Member States. Social assets play an important role in the determination of the value of the land. This is represented by the complex of informal interpersonal relationships

present within a determined territory, professional expertise, relationships of trust, mutual understanding, etc. It is also important to take into account the impact that interest rates, inflation, and other macroeconomic factors have on the value of agricultural land varies greatly between countries. The destination of land for the production of bio-energy may also have an effect on the market value of the land itself; although, at the moment, we do not have sufficient information to make an accurate estimation. According to some authors, the presence of bio-energy farms does not appear to have any impact on the value of agricultural land, except in the cases of some countries including Germany, Spain, and Holland. The situation may change in the future: an increase in demand for land for energy cultivation could trigger a revival in the demand for agricultural land, and, as a result, increase its value (Swinnen et al., 2008). In recent years, there has been a general reduction in the number of farms, along with an increase in average area. However, the influence of farm size on sale and rental values varies according to region and in relation to the type of activity performed. Certainly, another factor which influences the value of land is the structure of the work force.

Finally, there are many aspects not strictly linked to agricultural activity which concern the land market and can have a negative or positive impact on it. For example different land uses, including industrial and commercial activities, residential and recreational use, and infrastructures, determine different market types which are often overlapped and linked. In particular, in relation to this last aspect, it is believed that the link between the land market and other markets is quite strong, and therefore the correlation between the value of land and the expansion of urban centres is also quite strong. The construction potential of a piece of land definitely makes it more valuable, as does the presence of an efficient infrastructural system and proximity to the markets, both of factors and products. The demand for buildable land is not thus affected by soil quality as it is for agricultural land, but in any case involves a reduction in the land factor and thus also affects the value of agricultural land. Furthermore, within the same agricultural activity, competitive phenomenon for the purchase of agricultural land may also exist, as happens between producers of food crops and producers of crops for energy purposes.

In reference to the relationship between supply and demand within the agricultural land market, it should also be noted that a certain amount of land is put on the market every year for several reasons including, for example, the retirement or death of property owners, and only a small part of this land is sold. Furthermore, land, as a factor of production, represents a value reserve, and additional demand for land may occur during periods of inflation or economic uncertainty.

6.3 Statistical characteristics of the FADN sample and the features of the study

The FADN is a sample-based survey, carried out annually by EU Member States in order to collect homogenous and comparable information on agriculture within the European Union. It was established in 1965 by the European Economic Community Commission with Regulation (EEC) n. 79/65, with the aim of gathering information on the situation of farms across EU States through a direct and systematic survey of all administrative factors arising during the financial year. The information required for the FADN is related to both physical and structural data such as localisation, cultivated area, heads of cattle, workforce etc., and financial and economic data such as the value of production, sales and purchases, benefits etc. The FADN thus represents a fundamental informative tool which supports the European Commission, in the managerial decision-making process and the development of the Common Agricultural Policy. On a national level, FADN management is assigned to a liaison agency that is represented in Italy by INEA, which since 1965 (Presidential Decree number 1708/65) has been responsible for selecting farms and collecting data. Until 2002, farms forming the FADN Italian sample participated in the survey on a voluntary basis, however since 2003 the FADN surveys are carried out in coordination with the survey on the Economic Performance of Farms (REA) performed by ISTAT (Italian National Statistics Institute), in implementation of Reg. EC 2236/96. This has led to the unification of the surveying structure and the adjustment of survey methodologies in order to guarantee a greater level of statistical rigour, according to which only a random selection fully guarantees the requirements of probability, and allows for a sample error estimate. Therefore,

since 2003 the Italian FADN has been based on a random stratified sample; farms are chosen based on a selection plan, and must be representative of the entirety of farms belonging to a defined observation field, according to three factors: region, economic size, and farm type, and an individual weight is applied to each of the farms in the sample.

The survey field of observation is based on the 5th general agricultural census, updated with the Farm Structure Survey (FSS), carried out by ISTAT on a two-yearly basis, the FADN-REA and other specific surveys carried out by ISTAT.

The farms participating in the FADN survey are selected based on a sample plan drafted in each Member State, in conformity with Regulation (EEC) number 1859/82, in order to guarantee representation of the entirety of farms comprising the field of observation. Until 2009, the reference threshold for entering into the FADN sample was 4 European Size Units (ESU), whereas from 2010, the FADN sample included all farms in the EU universe¹ with a standard production of at least 4,000 Euros.

The methodology used to allocate farms across the strata is, in practice, an extension of the Neyman method in the case of more than one variable, and then adopts a generalisation of the Bethel proposal as a resolution method (Bethel, 1989). This stratification is advantageous from a methodological point of view, as it succeeds in minimising the number of farms to be included in the sample to represent the variety of the field of observation, while maintaining sampling efficiency. Within the cells Simple Random Sampling is applied. As previously mentioned the three criteria considered for the stratification of the field of observation are territorial location; economic size; type of farming (TF), and they guarantee an effective gain in terms of the efficiency of the variables estimators (on a national and regional level).

Territorial location coincides with administrative districts, which correspond to the 19 administrative regions and to the two autonomous provinces of Trento and Bozen.

The farm economic size is expressed in ESU up to and including financial year 2009, whereas from 2010 onwards, economic size is expressed directly in Euros. The Type of Farming is defined by the regulation which establishes a community *typology for farms*.²

Once the number of farms to be included in the sample has been defined for each stratum, the selection of these farms is of equal probability and occurs randomly. The strategic variables for the allocation of sample units within the strata are those deemed to significant to agricultural economic analysis. For the sample design up to and including financial year 2009, the strategic variables were: Standard Gross Margin (SGM), gross production at basic prices, and costs. For financial years since 2010 the strategic variables are: Standard Output (SO), Utilised Agricultural Area (UAA), days of work and livestock expressed in terms of Adult bovine unit. For each of the strategic variables, the following are calculated: average and variance as weighted average. To obtain the desired level of accuracy for each individual strategic variable, maximum sampling errors are calculated, expressed as a percentage of the coefficients of variation, represented by the ratio between the standard deviation of the variable stratum and the estimation of the total of the stratum of the considered variable. The number of farms in the sample and its distribution across the strata is thus obtained by fixing the desired levels of accuracy, expressed as a percentage of the variation coefficients on the strategic variables, both on a national and regional level.

The optimum allocation of units within the strata not only depends on the size of one stratum, but also on the variability of the strategic variables within that stratum. Consequently, the smaller the internal homogeneity of one stratum is, the greater the number of units needed to obtain a representative sample will be.

The number of farms is obtained by using the coefficients of variation and by ensuring that there are no fewer than 5 units per stratum. In the event that the stratum contains a number of farms too small, and

¹ The EU field of observation consists of all companies operating within the agriculture sector with at least one hectare of utilised agricultural area (UAA) or with a production of at least 2,500 Euros; companies whose activity is exclusively forestry are not included in the EU field of observation.

² In particular, in order to respond to new modifications to the CAP and to the gradual disappearance of benefits linked to production, regulation (EC) n. 1242/2008 was approved, establishing a new community typology for agricultural companies which will be used from financial year 2010 and is based on the new Standard Output parameter and on the review of classification criteria.

that stratum has a scarce relevance in terms of standard gross margin (SGM), they may be aggregated (collapsed) with strata with similar size and/or with strata with similar Farm Type.

As regards the methods for collect information, the sample farms which fall above a determined economic size threshold, are collected for the FADN and REA through special accounting software (Continea until 2007 and Gaia since 2008), while farms that fall below this threshold will only be collected for REA through a paper questionnaire.

6.4 Available information, selection of study references and methods for estimating the variables which characterise the agricultural land market

As previously stated, the objective of the study is to verify the compliance of FADN information with the analysis of the Italian agricultural land market. The main variable concerned in the research is thus the market value of agricultural land. As known, given the nature of the link between soil and plantations, the variable in question normally includes both the value of land (bare land) and the value of the stand.¹ In our case however, as the FADN data is of accounting origin and as the plantations represent a land improvements, the values examined (land and stand) are estimated separately to allow for the amortisation of the plantations. The variables used to characterise the economic aspects of the land market are as follows.

- *Value of agricultural land* - as mentioned, this refers to the value of the bare land and is estimated according to the most probable market value. It must be highlighted that the estimate only concerns farm-owned land (rented land is estimated separately), and that the evaluation process is carried out subject to the careful attribution of farming quality to farm land, so as to define the portions of these in which homogenous conditions can be verified, compared to the variables which influence the value of the land itself.
- *Value of plantations* - is estimated according to the most probable replacement value and is calculated at current prices using 'ordinary technique' that is, considering all the costs normally sustained in the area to develop the plantation under examination, and for all the years of the plantation phase.

Considering the different criteria used for the estimation of their value, it is important to highlight that the overall value of land (land and stand) cannot be derived from the sum of the individual values of land and stand. The replacement value of the stand cannot be so simply assimilated to the proportion of the market value of the entire asset, attributed to the stand². Despite this, it was nevertheless deemed necessary to provide information relative to the value of the plantations as it represents the cost which, according to the FADN, must be sustained for their development, and also because, in certain conditions (normally), they may support experts in formulating particular value judgements.

- *Rent* - is supplied for the same farming quality for which the land value is supplied and does not present any peculiarities. As shown below, the main connected problem derives from the frequent omission of the reason for its payment.

As previously mentioned, the variables involved in forming the value of agricultural land are numerous. However, it has been observed that location and production aim are among the most important as they define the market in which the asset is inserted, the degree of usability of the asset and the real or potential use for which the asset may be destined. For the purposes of this research, therefore, the classification of agricultural land depending on these two variables is extremely useful, as it allows us to obtain a considerable reduction in the field of variation of the concerned variable. The territorial ref-

¹ In accordance with the economic-estimate terminology, the term 'stand' refers solely to plantations. Other eventual land improvements which may exist on the sole are in fact, not taken into consideration as they are extraneous to the concept of agricultural land (buildings and/or manufactured products in general) or, conversely, because they are incorporated within it (stone removal, surface organisation, etc.).

² The first teaching of the Estimate is that the value of an asset derives from the reason for which the estimate was conducted. For further information on the subject, refer to the specialist literature.

erence of data produced by the FADN is, however, the administrative municipality, and the information relative to land is supplied with reference to different farming qualities. In consideration of these facts, especially if they refer to the consistency of the FADN sample, it is necessary to mediate the available information in the context of larger territorial and farming references. In fact, failure to do so may mean that their lack of strength may make their average value unreliable. It is also important to note that the references under examination carry out a very important role, not only with regard to statistical aspects of information which will be produced, but also on its usability. The role carried out in one of these fields goes in the opposite direction to the role carried out in the other: the more detailed the references are, the more the produced information is usable, but the less 'solid' it will be. Considerations developed for choosing the references under examination can be summarised as follows.

- *Macro-areas* - Having discarded the possibility of representing the value of agricultural land by referring to administrative municipalities, the area which seems to be the 'second best' option, is that which arises from the intersection between administrative provinces and altimetric zones.¹ These areas in fact allow for a decent level of solidity of FADN information, and possess characteristics that make them particularly suited to the aim. These characteristics are:
 - administrative singularity which guarantees homogenous conditions of socio-economic development and thus homogenous market conditions across the whole territory;
 - homogenous orographic and pedoclimatic conditions which with the aforementioned characteristics, guarantee the homogeneity of agricultural land use and profitability of this land.

With regard to the areas in question, however, some clarifications and considerations are necessary about the type of altimetry used and homogeneity of the agricultural land value detected within it. With regard to the altimetry used, the choice is between territorial altimetry, determined and normally used by ISTAT², and effective altimetry (metres above sea level). The main advantage offered by ISTAT altimetry is that it allows to obtain merged and quite large areas of reference (from which the terms macro-zone and macro-area derive), which are therefore easily recognisable. On the other hand, the main disadvantage connected to the use of this type of altimetry derives from its definition, i.e. often the altitude 'declared' in its name does not correspond to the effective altitude of the location in question. Within each altimetry, ISTAT, in practice, can combine different types of effective altimetry with sometimes significant variations. It is obvious that this fact, together with the position of the land, contributes to an increase in the variability of the phenomenon concerned in the study. The main advantage offered by effective altimetry, on the other hand, is that it allows for the delimitation of the relatively 'limited' layers, which therefore includes land that, for the variable concerned, is much more homogenous than that delimited by ISTAT altimetry. The main disadvantage connected to the use of this type of altimetry is that, especially in territories with very variegated orography, (the vast majority in Italy), the aforementioned 'limited' layers delimit reference areas which are not merged but spotted. As mentioned previously, this significantly reduces the usability of the produced information, as the identification of zones in the piece of land concerned is a lot less immediate. Furthermore, as already suggested, the position of the land may influence its value, perhaps to a greater extent than effective altitude. Common sense thus indicates that if you explain the consequences of effective altitude, you should also explain the effect of position. This is why a matrix capable of defining altimetric zones through an appropriate combination of predetermined classes of effective and gradient altimetry is necessary (Seroglia, 2003). But this in practice makes the information produced unusable as the reference area is fragmented into a myriad of micro-zones where it is no longer easy to locate any land if not through the measurement and calculation of effective altitude and average gradient. Upon final analysis, this is why ISTAT altimetry is preferred. Finally, with regard to the variability of the value of agricultural

¹ Between the municipal territory and that of the altimetric zone, another territorial aggregate exists: the agrarian region. This, however, other than being relatively small to confer sufficient solidity to the FADN data, is not characterised by its socio-economic development conditions. It is therefore a mere and perhaps excessive fragmentation of the afferent territory into a provincial altimetric zone.

² For a definition of the zones concerned, refer to the ISTAT Agricultural Statistics. It is important to note however, that these include whole administrative municipalities. In other words, the area of administrative municipality data must fall within a single altimetry.

land, as has been previously mentioned, the value depends on numerous variables, which are not even all ascribable to the economic sphere. Confining its variability in the context of a reference zone (besides of a farming quality) is not even worth considering. Such a hypothesis would in fact be excessively risky, even for a much reduced territory with extremely homogenous orographic characteristics. In fact, even in these circumstances, there would certainly be some variables which would not exert their influence in a uniform manner across the entire municipal territory. Distance from the populated centre, distance from the main road leading to the town, the presence of a motorway junction in a neighbouring town or, on the other hand, the presence of a small town with high schools or a hospital, are all examples of variables which act on the development of a territory and therefore, also put pressure on the value of neighbouring agricultural land.¹ Furthermore, it is evident that, as long as there is no reliable evidence over a least the medium-term, that the aforementioned land will soon be changed into land for urban planning (an event that, among other things, would be made clear by an abnormal increase in the value of the land, which would no longer have anything to do with agricultural value), it would be a serious methodological error to exclude their input from the estimate of the average value of agricultural land, simply because the land under examination is agricultural land, and will probably remain so for another half a century if not more, and has that value. Excluding these lands would therefore only mean underestimating the value. The size of the zone of reference definitely influences the variability of agricultural land value. However, the variability component which can be attributed to the size of the adopted area (provincial altimetric zone) is not greater than the variability which is attributable to other factors and, in any case, there is no chances of avoiding it.

- *Macro-crops* - As previously mentioned, crop qualities of agricultural land, surveyed through INEA accounting methodologies, are numerous. The unification of these into larger crop qualities (defined as macro-crops), aimed at increasing the statistical robustness of the information to be produced, is carried out while respecting the constraint of the physical homogeneity of the crop qualities (Table 6.1.a). In other words, similarly to the identification of reference areas, we proceeded to the unification of qualities of crop to obtain macro-crops that are easily recognisable.

The essential features of the obtained macro-crops can be defined as follows:

- *Dry arable lands*: arable lands without a stand² or the possibility of irrigation. They can be flat or sloped and their soils may contain stones. The steepness and/or the presence of stones however, does not necessarily have to stop mechanical works from taking place on the land;
- *Irrigated arable lands*: irrigable lands with no stand. They are generally flat with a minor gradient and have no or very little stone presence (because they are allocthonous) Irrigability does not necessarily have to be attested by the presence of a fixed irrigation system;
- *Orchards/vineyards/olive groves*: dry or irrigable arable lands with a stand composed of fruit trees, vines or olive trees, respectively;
- *Pastures*: non-arable lands, generally for physical reasons (excessive altitude, steepness or stone content), whose grass production is only usable through the grazing of domestic animals;
- *Woods*: any type of land covered by trees and/or forest shrubs.

Furthermore, some crop qualities included in the accounting methodologies were not taken into consideration as they do not pertain to agricultural land or because they have a marginal relevance. Nursery activities are not considered because they are not unequivocally ascribable to any of the identified macro-crops, and, at the same time, are not sufficient to represent a macro-crop. Moreover, with regard to the

¹ A curious thought: it would seem than in Italy, the anthropisation of the land is such that it does not allow one to trace a 10 km diameter circumference without including at least one built-up area.

² As shown in the table, wooded crop qualities also pertain to the arable land macro-crops. However, we would point out, as in the case of land qualities, those lands that are normally defined as wooded, in which only a few sparse trees are present, whose presence does not significantly influence the value of the land.

agricultural activities in question, as they can be grown on windowsills or in vases, as for some greenhouse production, it would also be necessary to consider them as crop qualities of agricultural land. Despite this, greenhouse flowers were included in the irrigated arable land macro-crop as they are associated with gardens which are normally soil-based, and because normally, greenhouse cultivation requires irrigation. Regarding the identified macro-crops, it is still necessary to clarify two aspects: their size and the relationships that may be established between the land values that are linked to them. With regard to the size of the macro-crops, it must be highlighted that, for various reasons, it was not deemed appropriate to proceed to the verification of the statistical existence of crop qualities of a smaller size than those which have been defined. Furthermore, as this is only practically possible for arable land (see Table 6.1a), it would have generated non-homogeneity both in the processing and production of information relative to the macro-crops (arable and fruit-bearing) which, instead, appears to be equivalent in terms of importance and size. Finally, it must be considered that the definition of crop sub-qualities would have led to the renouncing of easily recognisable macro-crops. This would not only generate a situation of little usability, similar to what has been previously described for the macro-areas, but it would have led to the necessary realignment of existing variability within the crop references with the variability of the territorial references. This is because, primarily upon examination in light of the actual agricultural techniques, these 'second level' crop qualities no longer contain the prerequisites to be considered veritable crop qualities, but are more like qualitative levels - or variability contexts - of their original crop quality. Finally, with regard to the relationships that are established between the values of the land connected to the different crop qualities, one can say that these are uniquely determined by the market and that this varies, as well as in the context of a macro-area or macro-crop, according to the variation of macro-areas and macro-crops. Hypothesising the existence of fixed relationships between the values of the land connected to the different crop qualities that surpass the borders of the macro-areas, is thus fundamentally flawed as it is equivalent to hypothesising that the market will always act in the same way, irrespective of location and the relative importance that different crop qualities have within it. Nevertheless, and only in consideration of the large differences that exist between macro-crops, some approximate indications on the relationships considered are as follows:

- the poorest land generally pertains to pastures and woods which are evidently the crop qualities that are characterised by the greatest limits in the use of the land itself;
- the possibility of irrigation, which increases the range of possible land uses, normally leads to an often considerable increase in the value of the land itself;
- irrigation possibilities being equal, elements necessary to establish a value ranking between arable lands, orchards, vineyards and olive groves are not apparent. On this point, it is important to remember that the presence of a stand does not automatically and necessarily translate into an increase in land value. The presence of a vineyard, for example, will certainly increase the value of the land under all circumstances in which the vineyard represents a consolidated and economically convenient productive reality, as it is in the zones characterised by high-quality production, for example. However, nothing guarantees that this will also be the case for zones where wine production does not possess the abovementioned characteristics. In these zones, therefore, the value of a vineyard may in fact be lower than that of arable land. Finally, in certain circumstances, the presence of certain stands may actually decrease the value of the land on which they are located.

The other contexts investigated in the study are the *mobility of agricultural lands and their value trends*. The examination of land mobility was preceded by a brief analysis of their availability, distinguished by form of possession (ownership, rent, and loan). True mobility, always expressed in percentage terms, thus refers both to the number of farms involved, and to the value of the land, as well as to the total of the sample area. The inference on the land value trend was instead carried out through a comparative examination of the values that the land assumes, in the context of a two-yearly panel of farms.

Finally, with regard to the estimation methodologies of the utilised variables, considering what has been said about the statistical representation of the FADN sample, the variables themselves were calculated on the basis of the simple arithmetical average of the available observations in the reference con-

texts selected; that is, without weighting the sample to the universe. Furthermore, considering some of the peculiarities relative to the formation of the FADN sample (replacement of farms with an annual rate of around 20-25%) and the predicted development of the study (estimate of the trend of the land market), to select the information to be used, the panel statistical technique was applied, instead of the outlier elimination technique.

6.5 Comments on the obtained results: economic aspects and the market dynamic

6.5.1 Economic aspects

- *The market value of land¹* - As previously mentioned, the lack of representation of the FADN sample for the variable concerned in the study has prevented any type of extension of the estimated data to the universe. The data which will be presented therefore consists of simple arithmetical averages. For this reason, and thus in order to support the reader in evaluating the quality of the produced estimates, they have been equipped with two indicators: the number of observations from which the estimate is derived, and the 'relevance' of the different macro-crops in the different macro-areas. In order to increase the number of observations per soil typology and geographical zone, it was decided to aggregate some crop typologies together, and not to investigate territorial areas that were less extensive than those arising from the intersection between administrative provinces and ISTAT altimetry zones. Furthermore, it was decided not to consider estimates that arise from fewer than five observations. With regard to the first indicator, a macro-crop was defined as relevant to a macro-area to the extent to which it consists at least 10% of the UAA (for woods the threshold is 20% of the total agricultural area of the macro-area). The incidence concerned was developed based on the data of the FSS 2007, and the occurrence of this situation has been highlighted by the shading of cells relative to the value of soils in Table 6.1a.

Table 6.1a Average value per hectare of land and number of observations per macro-crops and region (in euros)*

REGION**	DRY ARABLE LAND		IRRIGATED ARABLE LAND		ORCHARDS		VINEYARDS		OLIVES		PASTURES		WOOD	
	Val/ha	N. obs.	Val/ha	N. obs.	Val/ha	N. obs.	Val/ha	N. obs.	Val/ha	N. obs.	Val/ha	N. obs.	Val/ha	N. obs.
PIEMONTE	11.222	650	23.186	544	17.644	263	20.412	341			3.516	25	4.073	173
VALLE D'AOSTA	25.787	96	30.323	144	45.376	20	60.849	41			14.367	121	3.068	226
LOMBARDIA	34.183	284	50.333	571	50.654	45	39.239	114	58.415	5	5.659	29	15.327	126
ALTO ADIGE	6.791	106	26.462	13	38.787	91	30.000	31					3.177	79
TRENTINO	45.741	83	90.444	18	204.811	122	205.744	79			8.000	14	13.315	25
VENETO	36.905	282	48.979	375	58.559	81	55.074	187	63.708	6			18.707	49
FRIULI-VENEZIA GIULIA	20.382	455	25.779	211	27.278	35	27.895	276					9.651	197
LIGURIA	36.996	166	221.928	505	48.131	39	65.566	55	72.770	199	4.875	6	4.398	22
TOSCANA	11.392	392	41.089	135	10.887	11	18.169	209	11.785	224	4.532	24	2.755	207
UMBRIA	10.463	375	18.257	75	13.615	30	13.496	191	11.192	221	3.645	56	3.161	225
MARCHE	12.195	312	23.396	16	20.314	14	21.982	92	19.545	76	3.414	19	3.232	108
LAZIO	16.296	363	27.712	226	20.631	75	19.377	80	18.064	127	9.336	21	6.604	51
ABRUZZO	9.130	526	20.773	244	18.600	76	20.875	369	14.875	392	2.104	24	6.782	44
MOLISE	7.848	355	21.026	79	15.435	32	14.852	96	12.373	187	2.255	20	4.737	128
CAMPANIA	13.506	227	52.341	249	41.386	132	26.391	103	22.106	135	4.286	7	4.835	40
PUGLIA	12.858	420	16.566	182	15.647	170	19.640	320	13.118	568	3.968	45	6.888	49
BASILICATA	6.582	589	13.373	134	16.172	208	11.907	94	10.593	294	2.253	277	6.849	73
CALABRIA	7.977	184	12.676	236	24.632	127	16.234	39	15.310	357	2.677	53	7.689	6
SICILIA	8.928	712	28.475	264	18.127	235	14.044	275	12.453	361	4.529	223	3.727	11
SARDEGNA	6.370	440	17.837	225	20.021	34	10.811	70	10.969	71	3.999	262	4.378	51

* Cells with shaded background indicate the relevance of the macro-crop in terms of surface on total

** Data for the Emilia-Romagna are not available

Source: FADN panel database 2007

¹ The information reported below considers the regions as administrative authorities, however the study was conducted with reference to provincial and altimetry zones.

From Table 6.1a emerges that the data from the FADN database did not allow for an estimate of the average soil values where relevant in the regions of Alto Adige, Veneto and Friuli-Venezia Giulia. Furthermore, it is possible to note that the value estimate is particularly high in the regions of Trentino and Liguria. Specifically, in Trentino quotes of little over 200,000 Euros per hectare were estimated for orchards and vineyards, and 90,000 Euros for irrigated arable lands; the latter is estimated at around 220,000 Euros in Liguria (in this case, this refers to garden/flower-growing cultivated lands).

With regard to the detail for macro-crops, the dry arable land varies from a maximum of 45,741 Euros per hectare in Trentino to a minimum of 6,370 Euros in Sardinia; the irrigated arable land varies from 221,928 in Liguria to 12,676 in Calabria; the orchard from 204,811 in Trentino to 10,877 in Tuscany; the vineyard from 205,744 in Trentino to 10,811 in Sardinia; the olive grove from 72,770 in Liguria to 10,593 in Basilicata; the pasture from 14,377 in Valle d'Aosta to 2,104 in Abruzzo; and finally the wood from 18,707 in Veneto to 2,755 in Tuscany.

- *Replacement values of plantations* - First of all, it is necessary to specify that by keeping the variability of examined values greater among the crops than among geographical areas, it is not necessary to use the same territorial and crop references adopted for the land in order to determine them. The references adopted in this case are the administrative region and individual crop. As regards the values obtained as shown in the examination of Table 6.1b, the highest values are for the vineyards, followed by the orchards and then olive groves. Evidently, this must be connected both to the number of plants per hectare needed to create the plantation in question (which normally decreases as we move from vineyards to orchards, to olive groves), and to the cost of materials and workforce needed to create supports for the vineyards (rows, trellises, nets). In the Alpine regions, the values are also much higher for orchards. This is probably connected both to the greater unitary costs of executing extraordinary works on the land, caused by the orography, and the widespread presence of crop protection systems against frost and hail (nets, irrigation systems, etc.). In Valle d'Aosta, the replacement values of plantations are also sustained by the regional policies to reorganize landed property which establish good levels of compensation for the expropriation of land with plantations. Finally, all types of plantation have a replacement cost which tends to decrease from the north to the south of the country.

Table 6.1b Costs of plantation per hectare

	Stands		
	Orchards	Vineyards	Olive
Valle d'Aosta	30.942	40.713	
Piemonte	8.767	17.027	
Lombardia	19.389	21.262	16.686
Trentino	18.908	21.101	
Alto Adige	29.726	25.786	
Veneto	13.639	15.756	9.171
Friuli Venezia Giulia	20.701	17.176	9.408
Liguria	8.855	17.929	12.748
Toscana	13.505	27.100	11.549
Marche	7.226	12.817	7.839
Umbria	12.251	15.618	9.289
Lazio	10.102	10.119	8.444
Abruzzo	8.929	11.936	7.292
Molise	6.188	9.565	6.008
Campania	6.669	9.733	6.909
Calabria	8.986	8.643	6.928
Puglia	6.839	14.508	6.907
Basilicata	5.168	6.614	4.328
Sicilia	7.325	8.701	5.776
Sardegna	13.077	9.623	8.007

Source: our elaborations on FADN data

- *Rent payment* - The registration of payable rent in the FADN survey mainly occurs through two fields: rent amount and the reason for payment. Unfortunately, the completion of the field relative to the reason for payment is not compulsory, and thus often, it is omitted or filled out in insufficient detail. The consequence of this is that in 6,700 registrations that occurred in 2007 for payable rent, the reason for the rent payment is only known in 7.7% of cases. In Table 6.1c, the average annual rent payments for land arising from the processing of usable information are displayed according to macro-crop and district. As can be observed, their statistical worth is often very low and they are almost completely unusable insofar as, they refer to geographical areas that are too wide. Within them however, there is a certain likelihood that, having been confirmed in order of size by data published in the INEA Annual Report, they may at least have some value as indicators of the real rent level. To conclude, it should be highlighted that the scarcity of information relative to payable rent is only a contingent fact; that is, it is only due to the failure to use the information over the years. In other words, there is nothing to stop the compilation of the reason for rent payments for land from becoming compulsory in forthcoming financial years.

Table 6.1c Rents per geographic division and macro-crop

	District							
	North		Center		South		Italy	
	€/ha	cases	€/ha	cases	€/ha	cases	€/ha	cases
Dry arable land	250,00	7	250,00	77	118,00	174	161,00	258
Irrigated arable land	339,00	35	1.063,00	5	525,00	87	495,00	127
Orchards	880,00	1			398,00	5	478,00	6
Vineyards	621,00	5	635,00	3	285,00	4	512,00	12
Olives			487,00	1	321,00	19	329,00	20
Pastures	45,00	7	40,00	3	63,00	82	60,00	92
Total		55		89		371		515

Source: Our elaborations on FADN data.

6.5.2 Market dynamic

In the 2007 FADN sample, it appears that lands were neither sold nor purchased by farms in the regions of Liguria, Umbria, and Calabria. In the remaining 17 regions, the number of sold/purchased lands is shown in Table 6.2a (values as percentage of the regional total of the single macro-crop).

Table 6.2a Number of sold/purchased lands on total (%) *

Region	Dry arable land	Irrigated arable land	Orchards	Vineyards	Olives	Pastures	Woods
Piemonte	0,09	0,10					
Valle D'Aosta	1,98	2,24				0,23	0,29
Lombardia		0,11					
Trentino	1,74		1,22	1,23			
Alto Adige				1,37			
Veneto	0,42	0,28		0,32			
Friuli-Venezia Giulia	0,74	1,08		0,42			0,69
Toscana	0,42			0,28		1,72	
Marche	0,17						
Lazio	0,17	0,52		0,80			
Abruzzo	0,30			0,21			
Molise	0,20				0,35	1,96	
Campania							1,69
Puglia	0,64	0,38		0,45	0,38	1,19	1,18
Basilicata	0,11		0,36				
Sicilia	0,11	0,61	0,27				
Sardegna	0,11	0,17				0,18	

* data for Emilia-Romagna are not available

Source: FADN database 2007

The greatest activity is registered in Valle d'Aosta, where 2.24% of irrigated arable land was put on the market. The lowest level of activity was in Piedmont (0.09%), concerning dry arable land. As expected, dry

arable lands registered sales in almost all of the regions (excluding Lombardy, Alto Adige and Campania), followed by irrigated arable lands, vineyards, and, at the end of the list, orchards and olive groves. There are only four regions that register land sales in a single macro-crop, Lombardy (irrigated arable land), Alto Adige (vineyard), Marche (dry arable land) and Campania (woods).

If we instead consider the percentage of the area of land sold for macro-crops across the regional total, it emerges that the highest percentage is in Tuscany for pastures at 3.16%, while the lowest is in Valle d'Aosta for pastures at 0.00% (Table 6.2b). It is worth highlighting that in Puglia 2.17% of the dry arable land and 1.29% of woods were sold/purchased. In Campania the percentage reached 1.53% of the wooded area of the regional FADN sample.

Table 6.2b Agricultural Area of sold/purchased lands on total (%)*

Region	Dry arable land	Irrigated arable land	Orchards	Vineyards	Olives	Pastures	Woods
Piemonte	0,00	0,01					
Valle D'Aosta	0,23	0,09				0,00	0,01
Lombardia		0,01					
Trentino	0,17		0,27	0,46			
Alto Adige				0,19			
Veneto	0,04	0,04		0,06			
Friuli-Venezia Giulia	0,60	0,15		0,05			0,23
Toscana	0,06			0,12		3,16	
Marche	0,02						
Lazio	0,01	0,19		0,70			
Abruzzo	0,03			0,05			
Molise	0,12				0,09	0,03	
Campania							1,53
Puglia	2,17	0,02		0,03	0,07	0,02	1,29
Basilicata	0,03		0,05				
Sicilia	0,09	0,05	0,04				
Sardegna	0,01	0,01				0,00	

* data for Emilia-Romagna are not available

Source: FADN database 2007

Finally, if we analyse the data on sales as a percentage of the value of land sold for macro-crops across the regional total, the highest value is that of Puglia for dry arable land, at 3.01%, while the lowest is found in Tuscany for pastures. The percentage of the value of sold land destined for woods in the Campania sample, 1.12%, and that of dry arable land in Friuli-Venezia Giulia, 1.01%, are also worth highlighting.

Table 6.2c Value of sold/purchased lands on total (%) *

Region	Dry arable land	Irrigated arable land	Orchards	Vineyards	Olives	Pastures	Woods
Piemonte	0,00	0,01					
Valle D'Aosta	0,34	0,17				0,00	0,01
Lombardia		0,02					
Trentino	0,24		0,46	0,53			
Alto Adige				0,22			
Veneto	0,07	0,07		0,12			
Friuli-Venezia Giulia	1,01	0,18		0,39			0,19
Toscana	0,07			0,18		0,00	
Marche	0,01						
Lazio	0,01	0,10		0,38			
Abruzzo	0,08			0,05			
Molise	0,15				0,08	0,27	
Campania							1,12
Puglia	3,01	0,03		0,02	0,06	0,02	0,04
Basilicata	0,00		0,17				
Sicilia	0,03	0,11	0,04				
Sardegna	0,01	0,01				0,01	

* data for Emilia-Romagna are not available

Source: FADN database 2007

With regard to the variations in the value of land, differing trends have been detected. Granted that the variations in absolute value are normally very contained, the downturns in the value of land do not just appear in mountainous areas and poorer crops, as we have been led to believe, but also in flat and hilly areas and in normally rewarding macro-crops. This contributes to outline an overall static framework which is correspondent to that which is typical of the Italian agricultural land market.

6.6 Comparative examination of the study results

In a study conducted with the objective to verify the compliance of FADN information with the examination of the Italian agricultural land market, the comparison of the results of the study with other pre-existing information on the subject seems to be compulsory. On this point, besides the FADN, the only structured sources existing in Italy are the INEA Survey on the land market and the so-called Average Agricultural Values (AAV). The main characteristics of the two sources are as follows:

- the values produced from the INEA survey on the land market refer to bare land (as do the FADN values) and relate to it through different crop qualities and geographical zones. The information published in the INEA Annual Report refers or is attributable to the following crop qualities¹: 1 - Irrigated arable land (excluding horticulture), 2 - Dry arable land (excluding horticulture), 3 - Horticulture, flower growing and nurseries, 4 - Permanent meadow, 5 - Pasture, 6 - Orchard, 7 - Citrus plantation, 8 - Olive grove, 9 - DOC Vineyard, 10 - Table grape vineyard, 11 - Non-DOC vineyard and others. The territorial references used in this publication, which at times assume the connotation of provincial altimetric zones (e.g.: Alexandria plain, Como plain, Brescia hills, etc.) and at times, assume that of municipal or sub-municipal areas (e.g.: Canelli zone, plain of Casale Monferrato, plain of Fucecchio, etc.), are very heterogeneous. Furthermore, they are combined (or replaced) with (or by) references to particular farm typologies (e.g.: zootechnical farm in the high plain of Reggio Emilia, irrigated fruit farm in high Ferrara,

¹ In reality, the crop qualities used are more numerous than those listed because often Orchards are replaced by the description of what is cultivated (Apple trees, Nut trees, Peach trees, etc.).

wine-growing farm in Valdarno, etc.). The data available on the Institute's website instead make reference to the following crop qualities: 1 - Arable lands, 2 - Meadows and pastures, 3 - Orchards, 4 - Olive groves, 5 - Vineyards. The territorial references used in this case are the provincial altimetric zones defined based on the ISTAT altimetry in five zones¹;

- the AAV are the values produced by the Provincial Expropriation Committees for the calculation of due compensation in the case of the expropriation of agricultural land. These values are determined on the basis of the value of land that is free from agricultural contract commitments and with reference to the crops currently used in the zone. Normally, they include the value of the land and the stand, but it is quite common to find references to the value of the land alone and usually they are referred to cadastral qualities. Nevertheless are not rare cases in which the definition of the crop quality concerns the form of growth (rows, trellises, nets, etc.) and/or systems of production (traditional, DOC, organic), as well as the species cultivated. Finally, their territorial reference is represented by the so-called Agricultural Region².

Considering what has been mentioned above, it is very difficult to compare the results of the study with the land values published in the INEA Annual Report or with the AAV. On the other hand, is very simple the comparison with land values available on the Institute's website as in this case, the crop and territorial references of the information are almost identical. In order to overcome the slight differences existing between these references, it is enough to duplicate the information produced by the source showing the smallest crop or territorial detail and use this to develop the source with greater detail. The matching of values created via the aforementioned procedure is briefly highlighted in Table 7a.

Table 7a Comparison between FADN and Land Market survey references

Crop references		Territorial references	
FADN	Land Market survey	FADN	Land Market survey
Dry arable land	Arable land	Mountain	Coastal Mountain
Irrigated arable land	Arable land	Mountain	Internal Mountain
Orchards	Orchards	Hill	Coastal Hill
Vineyards	Vineyards	Hill	Internal Hill
Olives	Olives	Plain	Plain
Pastures	Pastures and meadows		

Source: our elaboration

Once the data has been combined in this way, they can be compared immediately. Furthermore, in order to assess the overall affinity, their differences are classified into four classes of variations in absolute

¹ That which subdivides mountain and hill altimetric zones into 'coastal' and 'inland'. The combination of this altimetry with provincial territories leads to the identification of 289 geographical zones. The combination of the ISTAT altimetry within this subdivision (used for the processing of FADN data) with the provinces instead defines 238 reference zones.

² The agricultural region is a homogenous territorial subdivision composed of neighbouring municipalities within the same province, whose land has similar natural (climate, geology, relief etc) and agricultural (crops) characteristics. The main aim is cadastral or better, an assessed valuation, to determine the average agricultural values of the land, not so much for fiscal reasons than for expropriationary reasons, for example. It is one of the territorial levels used by ISTAT to acquire statistical data within the field of agricultural economics (the subsequent aggregations are the ISTAT altimetric zone and the province), which is thus defined 'Agricultural Region: composed of groups of municipalities according to the homogenous and territorial rules of continuity, in relation to certain natural and agricultural characteristic and then aggregated according to altimetric zone'.

value, and a further four classes of variation in percentage terms. The result of the classification is shown in Table 7b.

Table 7b Differences between FADN and Land Market survey values per classes of variation in percentage and in absolute value

Classes of variation in absolute values (€)	Classes of variation in percentage				Totale
	<5	5-25	25-50	>50	
	<i>Number of cases</i>				
<5.000	71	198	110	37	416
5.000 - 24.999	1	42	122	142	307
25.000 - 49.999		1	9	44	54
> 50.000				25	25
Total	72	241	241	248	802
	<i>Percentages</i>				
<5.000	9	25	14	5	52
5.000 - 24.999		5	15	18	38
25.000 - 49.999			1	5	7
> 50.000				3	3
Total	9	30	30	31	100

Source: our elaboration on FADN data and Land Market survey

As shown, the two series of data exhibit differences which in 52% of cases are very small (less than 5,000 Euros) and in the remaining 38% of cases are not excessive (between 5,000 and 25,000 Euros). Examined in terms of percentage variations, the differences in 10% of cases are less than 5% and for the remaining 90% of cases, differences are distributed in a nearly uniform manner across the remaining percentage classes of variation. In order to gain more information on the nature of these differences, Table 7c was created in which the details of all cases generating larger differences of variation are reported (variations greater than 50% and greater than 50,000 Euros), but these represent only 3% of cases. Before examining the tables, we specify that:

- the FADN values are defined according to ISTAT altimetric zones which are only distinguished on an altitude basis and not on the basis of proximity to the sea;
- the Land Market values are defined based on macro-crops which do not distinguish between dry and irrigated arable land;
- the AAV, which are reported in the table, do not carry out an explanatory function with regard to the market value of agricultural land¹, for the simple reason that they are not generated by the market but by special committees for compensation in the case of expropriation. Nevertheless, as they refer to agricultural land, in the context of the examination, they may be used to our benefit as indicative values. Furthermore, their analysis is deemed useful insofar as, they may prove to be potential elements of clarification for certain situations or circumstances including, for example, the existence (or ab-

¹ Otherwise, it would not have been deemed useful to develop the study in question.

sence) of certain macro-crops in certain territorial environments or the degree of variability in the unitary value of these macro-crops, depending on forms of breeding, systems of cultivation, etc. Therefore, considering the fact that more than one agricultural zone will normally fall within a certain provincial altimetric zone, Table 7c was created in order to predict a minimum and maximum AAV for each macro-crop. Evidently, this was created in order to make the comparison of AAV with other values technically possible, but also to allow for an estimate of the aforementioned variability. Finally, in the table notes, the numbers of the agricultural regions to which the indicated AAV refer are reported.

Table 7c List of FADN and Land Market survey values that show variations greater than 50% and greater than 50,000 Euros

Province	Altimetry		Macrocrop		Value			Notes	
	FADN	Land Market	FADN	Land Market	FADN	Land Market	VAM		
							Min.		Max.
Imperia	Hill	Coastal Hill	Dry arable land	Arable land	63.332	229.000			
Imperia	Hill	Internal Hill	Irrigated arable land	Arable land	223.500	53.100			
Imperia	Hill	Internal Hill	Vineyards	Vineyards	94.594	21.000	67.393	RA 3	
Imperia	Hill	Coastal Hill	Vineyards	Vineyards	94.594	33.300	87.677	RA 5	
Imperia	Mountain	Internal Mountain	Vineyards	Vineyards	114.286	32.800	81.134 87.677	RA 1 e 2	
Imperia	Hill	Internal Hill	Olives	Olives	95.918	28.200	67.393	RA 3	
Imperia	Hill	Coastal Hill	Olives	Olives	95.918	40.700	47.306 54.043	RA 4 e 5	
Savona	Hill	Coastal Hill	Dry arable land	Arable land	22.022	185.100			
Savona	Hill	Internal Hill	Irrigated arable land	Arable land	228.338	62.100			
Savona	Mountain	Internal Mountain	Irrigated arable land	Arable land	196.643	10.400			
Savona	Mountain	Coastal Mountain	Irrigated arable land	Arable land	196.643	56.700			
Savona	Hill	Internal Hill	Orchards	Orchards	88.346	20.400	28.877 66.880	RA 4	
Genova	Hill	Internal Hill	Dry arable land	Arable land	12.156	112.900			
Genova	Hill	Coastal Hill	Dry arable land	Arable land	12.156	128.100			
Genova	Mountain	Coastal Mountain	Dry arable land	Arable land	6.245	113.600			
Genova	Hill	Internal Hill	Irrigated arable land	Arable land	56.521	112.900	26.512 30.450	RA 7	
Genova	Hill	Coastal Hill	Irrigated arable land	Arable land	56.521	128.100	38.842 40.174	RA 8	
La Spezia	Hill	Internal Hill	Dry arable land	Arable land	8.700	58.700			
Verona	Hill	Internal Hill	Vineyards	Vineyards	85.912	216.300	103.420 184.740	RA 4 e 5	
Verona	Plain	Plain	Vineyards	Vineyards	65.544	123.200	61.860 175.450	RA 6, 7, 8 e 9	
Treviso	Hill	Internal Hill	Vineyards	Vineyards	41.296	105.600	91.000 133.000	RA 1 e 2	
Gorizia	Hill	Internal Hill	Vineyards	Vineyards	18.592	69.400	45.000 100.000		
Pistoia	Hill	Internal Hill	Irrigated arable land	Arable land	112.273	42.600			
Napoli	Hill	Internal Hill	Irrigated arable land	Arable land	85.565	28.600			
Messina	Hill	Coastal Hill	Irrigated arable land	Arable land	86.033	17.400			

Source: our elaboration on FADN data, Land Market survey data and Agency of the territory data

It appears from the examination of Table 7c that, first of all, the comparison is meaningless for almost all arable lands because the Land Market data are not differentiated according to irrigated or dry arable land, the large difference highlighted by the compared values may simply arise from the fact that we are comparing dry arable land with irrigated arable land or vice versa. The cases in question (all those not developed with the AAV) constitute over 50% of the cases presented in the table. From this, it is possible to deduce that, among other things, many of the differences described in the previous table (Table 7b) can be ascribed to cases that are analogous to those just observed and are therefore inexistent. The only cases of arable lands reported in the table which seem to present significant differences that cannot be attributed to the aforementioned circumstances, are the irrigated arable lands of the hilly zone of Genoa. In fact, in this case, the value indicated by the survey on the Land Market, is double compared to that of the FADN which already refers to irrigated arable land, cannot be justified if not by reference to small plots of land close to urban centres, normally classified as 'gardens' or 'flowers'. For agricultural region number 8 of Genoa (coastal hills of Chiavari), the AAV of 'irrigated gardens' are around 130,000 Euro/ha. It is

however important to note that in agricultural region number 7, the presence of the crop quality in question (irrigated gardens) is not even considered by the AAV and that, as far as being present in agricultural region number 8, the extension of this value to all irrigated arable lands in the provincial altimetric zone does not seem realistic. Other cases in which the differences between the FADN values and those of the Land Market, seem to signal the presence of anomalies, are those relative to the vineyards of the hilly zones of Treviso and Gorizia. In fact, under the hypothesis in which the AAV represent 'the size order' of the market value, the data produced by the FADN appears to have been excessively underestimated. On the other hand, cases of disagreement between the FADN and the Land Market relative to the orchards of Savona and the vineyards of Verona can be seen as cases in which the information produced by the surveys (FADN and Land Market) alternately place themselves at the limits of the range of variability described by the AAV. Finally, in cases of disagreement relative to the vineyards and olive groves of Imperia, in one in five cases, the data from the Land Market conforms better with the AAV than the information produced by the FADN while the opposite is true in the remaining four out of five cases.

To conclude, from the comparison carried out, it seems that the differences that exist between the FADN information and that of the Land Market, are more apparent than real. In fact, as was largely predicted, a significant part of the variations were produced by the comparison method used for arable land and are thus, inexistent. For the remaining part, except for in the presence of incongruent data, the differences detected are the direct consequence of the considerable variability that the phenomenon concerned in the study can cause, even in relatively restricted territorial and crop environments; variability, among other things, was also largely predicted upon the definition of the crop and territorial references of the study and widely proved by both the AAV and the variation fields defined by the same Land Market survey.

6.7 Concluding remarks

The objective of the study was the testing of FADN information in order to analyse the characteristics of the Italian agricultural land market.

The study began with a brief review of the determining factors of agricultural land value, from which it emerged that, at least in Italy, the value in question is more closely linked to non-agricultural factors (urban pressure and competition between different land uses) than to agricultural factors (price of agricultural products, agricultural productivity, CAP, etc.). This fact is reconciled with two well-known characteristics of the Italian agricultural land market: the market static tendency and the tendency to view the land as a 'shelter asset'.

The examination of available information, necessary for the methodological organisation of the study, was preceded by a brief description of the statistical characteristics of the Italian FADN sample. It was particularly noted that the Italian FADN uses a random sample which, in respecting the conditions established by the European Commission, is statistically representative of all the variables used in its stratification. Furthermore, it can be observed that the value of the land surveyed by the FADN was estimated according to the most probable market value and is net of the value of the plantations. The value of the stand, on the other hand, was estimated according to the most probable value of replacement, and registered separately in order to be subjected to amortisation. A significant step in the study was the definition of territorial and crop references, within which the available information was mediated. The inspiring criteria for the identification of these references were the statistical robustness of the information and the simultaneous usability of this information. This led to the identification of territorial references with the provincial altimetric zones defined based on ISTAT altimetry, and to the adoption of the following crop qualities: dry arable land, irrigated arable land, orchard, vineyard, olive grove, pasture and wood. It is important to note that they also have the advantage of being recognisable on a macroscopic level.

We then moved to the selection and processing of available information. Considering some peculiarities both relative to the formation of the FADN sample (replacement of farms with an annual rate of around 20-25%) and to the development of the study (estimate of land market trends), the panel technique was used to select information, as opposed to the outlier elimination technique. Furthermore, considering the

representation limits of the FADN sample the calculation of the average values of utilised variables (value of soil, value of plantations and rent payments for the land) was carried out through a simple arithmetic average.

Also considering the above, the results of the study were presented alongside two indicators: the 'relevance' of the macro-crop in the macro-area, and the number of observations upon which the average value calculation is based. Regarding the first indicator, a macro-crop was defined as relevant for a macro-area to the extent to which it influences at least 10% of its UAA (for woods the threshold is 20% of the total agricultural area of the macro-area). The relevance of the macro-crop is indicated with the shading as shown, with the only exception of pastures in three regions, the relevant macro-crops are always covered by the FADN information. Furthermore, the importance of the number of observations is an indicator of the quality of the data produced. It results from the study that the market value of land, calculated according to provincial altimetric zone and expositive commodity, was commented on in the text with reference to the regions and altimetric zones. The replacement value of the stands (plantations) was directly calculated by region and crop. For rent payments, it is observed that the lack of registration of the reason for rent payment reduced the amount of information available to such low levels that it does not allow for the production of information of a sufficient robustness, even on a regional level. The data available, which was nevertheless processed for macro-crop and geographical district, identifies some amounts that can be compared to those defined by other information sources.

The estimate of the market value trend was preceded by a quantification of available land according to type of ownership (ownership, rented and loaned) and also in terms of the number of farms and value, besides in terms of area. Ownership emerged as the main form of possession of land. Rental also emerged as very widespread, varying from around 20 to 50% in terms of area. Loaned land, on the other hand, was only spread to an appreciable extent in two or three regions. The estimate of market trend was thus carried out through an examination of the quantity of sales and the size of variations in land values. The examination of land mobility (quantity of sales), expressed in number, area and value, highlighted that the objects of exchange were mainly both dry and irrigated arable land, and vineyards. The size of the exchanges, in terms of area, is however normally much less than one per thousand of the available. From examining the variations in land values, it is possible to observe different trends. Granted that the registered variations in absolute are normally very contained, the drop in land values does not just occur in mountainous areas and poorer crops, as expected, but also in areas of normally profitable macro-crop plains and hills. This contributes to the outline of an overall framework that is more or less static and, quite correspondent with the typical framework of the Italian agricultural land market.

Considering the availability of information that is analogous to that obtained in the study, it was deemed necessary to proceed to a comparative examination of the results of the study with this latter information. For this reason, having examined the characteristics of the data produced by the INEA survey on the Land Market and that produced by the Provincial Expropriation Committees (AAV), so a comparison was developed using only the information from the INEA survey on the Land Market, published on the Institute website. The different territorial and crop references adopted in the other cases and the fact that the AAV are often included in the value of the stand as well, would have made the comparison very complex. In the case indicated, the data refers, similarly to that of the FADN, to the value of the bare land. Thus for the implementation of the comparison, only small adjustments were necessary, consistent with the assimilation of irrigated arable land of the FADN to the *tout court* arable land of the Land Market survey and, conversely, the assimilation of the coastal mountain and hill in the Land Market survey with the *tout court* mountain and hill of the FADN. The differences between this data were thus classified in terms of size classes, both in percentage and absolute value. This allowed us to verify that the vast majority of the differences pertain to small classes and that only 3% of differences pertain to the larger size classes. By individually examining these last cases, it was observed that more than 50% of them were caused by the methodologies use to match the data itself (comparison of dry arable land with irrigated arable land), and thus concerned differences that were in fact, non-existent. Finally, from the comparison of the cases in which differences are indicative of the presence of some phenomenon, using the AAV, which are still retained as being indicative of the market value of agricultural land, it seems to emerge that the differences

in question can be attributed to the phenomenon concerned in the study (reason for which the compared data can be placed at the extremes of the field of variation) or to the presence of some incongruent data. From the comparison in consideration, the frequency of these in the context of the FADN seems to be of the same size as that observed by the Land Market data.

To conclude, from what has been expressed above, it seems that the objective of the study has been reached with a positive result: the information surveyed by the FADN is ideal for an analysis of the characteristics of the Italian agricultural land market. Moreover, it appears much more valid if one considers that until financial year 2007, the data utilised was never subjected to any type of control; both because it was not requested at this level of detail by the Community FADN, and because it was never used.

6.8 References

Ballin, M. (a cura di), *Indagine sui Risultati Economici delle Aziende Agricole RICA-REA, Anni 2002-2003-2004.*, Istruzioni per la rilevazione delle variabili REA, ISTAT, Roma, 2004.

Bethel, J., 'Sample allocation in multivariate survey.' In: *Survey Methodology* 15 (1989) 15, 1.

Ciaian, P., D. Kancs and J. Swinnen, *Study on the functioning of Land Markets in the EU Member States under the influence of measures applied under the Common Agricultural Policy.* Centre for European Policy Studies (CEPS), Brussels, 2008.

Ciaian, P., D. Kancs and J. Swinnen, *EU land markets and the Common Agricultural Policy*, Centre for European Policy Studies, Brussels, 2010.

Ciaian, P. and J. Swinnen, *Land Market Imperfections and Agricultural policy Impacts in the New EU Member States: a partial equilibrium analysis.* Working paper 2005/1, Katholieke Universiteit, Leuven, 2005.

Commissione Europea RI/CC 1524. *Implementation of the new typology. New thresholds*, 2009.

Commissione Europea RI/CC 1526. *Guidelines for selection plans*, 2009.

Commissione Europea RI/CC1519 e successive revisioni, *Implementation of the new typology. FADN field of survey. 2010 selection plan working programme*, 2008.

Daouli, J. and M.P. Demoussis, 'Rents, Interest Rates and Real Agricultural Land Prices: An Application to a Greek Province.' In: *European review of agricultural economics* 1 (1992) 1.

De Vivo, C., T. Potenza, A. Muscio, R. Sileo and D. Tosco (a cura di), *Aspetti della redditività dei fattori produttivi nelle aziende agricole lucane, Analisi del campione RICA 2006, I quaderni dell'ALSIA.* 2006 <http://www.inea.it/sedi_regionali/basilicata/it/index.php?action=detail&id_cat=4&id_art=550>

Greco, M. and N. Mattaliano (a cura di), *Istruzioni per la rilevazione dei dati - Indagine sulla struttura e produzioni delle aziende agricole e principali coltivazioni legnose agrarie*, ISTAT. 2007 <<http://www.istat.it/strumenti/rispondenti/indagini/spa2007/2007/guida.pdf>>

Grillenzoni, M. and G.M. Bazzani, 'Agricoltura, uso dei suoli e mercato fondiario in Italia.' In *Genio Rurale* 4 (1995).

INEA, *Codici per la contabilità.* VIII edizione, 2000.

INEA, *Istruzioni per la compilazione del registro di rilevazione contabile e dei tracciati scheda*. 2001.

INEA, *Annuario dell'agricoltura italiana*. Volume LXI, 2007. *Edizioni Scientifiche Italiane*. 2008.

INEA, Istruzioni e linee metodologiche per la rilevazione ed il trattamento automatico dei dati RICA - CONTINEA ver. 7. <<http://www.agri.marche.it/Rica-Rea/programmi/Manuale%20Continea.pdf>>

ISTAT, *Struttura e produzioni delle aziende agricole*. Anno 2007.
<http://www.istat.it/dati/dataset/20090120_01/indexnp.html>

Just, R.E. and J.A. Miranowski, 'Understanding farmland price changes.' In: *American Journal of Agricultural Economics* 75 (1993) 2.

Karafotakis, E., J. Mylonakis and K. Kountouris, 'Price assessment of agricultural land in Greece.' In: *International Research Journal of Finance and Economics* 6 (2006).
<<http://www.eurojournal.com/finance.htm>>

King, D.A. and J.A. Sinden, 'Price formation in farm land markets.' In: *Land Economics* 70 (1994) 1.

Moller, L., S.H. Henter, K. Kellermann, N. Roder, C. Sahrbacher and M. Zirnbauer, *Impact of the introduction of decoupled payment on functioning of the German land market*. Country report of the EU tender: Study on the functioning of land markets in those EU member states influenced by measures applied under the Common Agricultural Policy, Discussion paper n. 129, Leibniz Institute of agricultural development in Central Eastern Europe. 2010.

Polelli, M. and S. Corsi, *Nuovi modelli interpretativi delle dinamiche del mercato fondiario*. XXXVII Incontro di studio del CESET, Firenze University Press, 2008.

Povellato, A., *L'andamento del mercato fondiario in Italia nel 2007* - Sintesi dei risultati. INEA, 2007.
<http://www.inea.it/prog/bdfond/it/index.php?action=detail&id_cat=49&id_art=1001>

Povellato, A., (a cura di), *Il Mercato Fondiario in Italia, Osservatorio sul mercato fondiario*. INEA, Dicembre 1997. <http://www.inea.it/public/pdf_articoli/86.pdf>
Regione Campania - *Assessorato all'Agricoltura, POR Campania 2000-2006, misura 4.10 Ricomposizione fondiaria, Analisi dell'effetto sul mercato fondiario della misura 4.10 all'interno della area eleggibile*.

Rondinelli, V., *La calibrazione dei pesi campionari delle aziende RICA nell'indagine sui Risultati Economici delle Aziende Agricole*. Contributi ISTAT n. 4/2009, ISTAT, Roma, 2009.

Seroglia, G. (a cura di), *La revisione del catasto terreni: contributi per un dibattito*. INEA, Maggio, 2003.

Swinnen, J. and L. Vranken, *Patterns of land market developments in transition*. Discussion paper 179/2007. LICOS Centre for Institutions and Economic Performance, Leuven. 2007

7 The incidence Farm Programs and the value of farm assets

Jennifer Ifft

The Incidence of Farm Programs and the Value of Farm Assets

Jennifer Ifft, Todd H. Kuethe, and Mitch Morehart
October 3, 2011
Pacioli – Tallinn, Estonia



Research Questions

- What is the impact of government payments on farmland values?
- Do different categories of farm programs have differing impacts on land values?

We are also interested in the impact on rents: almost half of cropland in the US is farmed by a tenant.

Policy Context

- **Budget/fiscal concerns are leading to calls to reduce farm program payments in the 2012 Farm Bill**
 - Direct payments are being scrutinized
- **Distribution of program payments varies by region and commodity**
- **Significant reduction or elimination of different programs will negatively impact local farmland values competing with other positive and negative influences**



This is a 'hot' topic right now in the US, many farm/commodity groups are recommending programs that are more countercyclical in nature. Direct payments are (mostly) 'decoupled', while countercyclical and disaster payments are not.

Contribution

- **Merger of several detailed, restricted data sets**
 - Large, nationally representative sample with per acre land values & rent
 - Disaggregate direct & countercyclical payments
- **Georeferenced with other determinant data sources**
- **Panel dataset, 1998 – 2010**
- **Farm or tract level analysis, with county level regressors**



Discovery

- Impacts vary based on aggregation level
- Direct (decoupled) payments have a large, positive & statistically significant impact
 - \$32 for an additional dollar for land values
- Countercyclical (coupled) payments have a negative relationship
 - Negative \$5.52 for land values
 - Negative \$0.05 for rent



Impacts vary based on whether or not farm program payments are aggregated. Interpretation of impacts: an additional \$1 in direct payments increases land values by \$32.

Literature

- Various methods used to address this issue
- Government payments have been shown to impact a large share of land values (15-30%), sometimes higher
- Direct/decoupled payments seem to have a larger impact on land rents
- Land prices are more responsive to govt. payments than market returns (Latruffe, 2009)
- Goodwin et al (2011) use cross sectional data to show that a \$1 increase in program payments leads to a \$13 increase in land values, several other studies show elasticity < 1.



Advantages of Data System

- Several potential measures for “land values”
- Differentiate capitalization rate by policy type
 - Direct (decoupled)
 - Counter-cyclical (coupled)
 - Disaster
 - Environmental and other
- Control for (subsidized) crop insurance



June Area Survey

- Completed entirely by personal interview during the first two weeks of June
- *Cash Rent and Land Values*
- Area frame
 - All land stratified by land use (all states, except Alaska & Hawaii)
 - 11,000 segments (roughly one square mile), which are sampled for 5 years
 - 85,000 agricultural and non-agricultural tracts identified within segments
 - 35,000 detailed personal interviews conducted
 - Sample weights allow for aggregation to state & national level



June Area Survey

Per Acre Land Values (field level)

- Cropland (irrigated and non-irrigated)
- Pastureland

Per Acre Cash Rents (farm level)

- Cropland (irrigated and non-irrigated)
- Pastureland

Farm Level Values (farm level)

- Real estate (land and buildings)



10-99 Data

- Farmers required to report all farm program payments to IRS as income
- Payments are broken down into individual categories
 - Additionally by direct or counter-cyclical program code
- Aggregate payments to the county level



IRS = US Internal Revenue Service.

RMA Data

- County level data on insurance premiums and indemnity payments
- 50-60% of crop insurance premium is subsidized
- RMA = Risk Management Agency (USDA)



Government Payments to Land Value Ratios*, County Average from 2006-2008

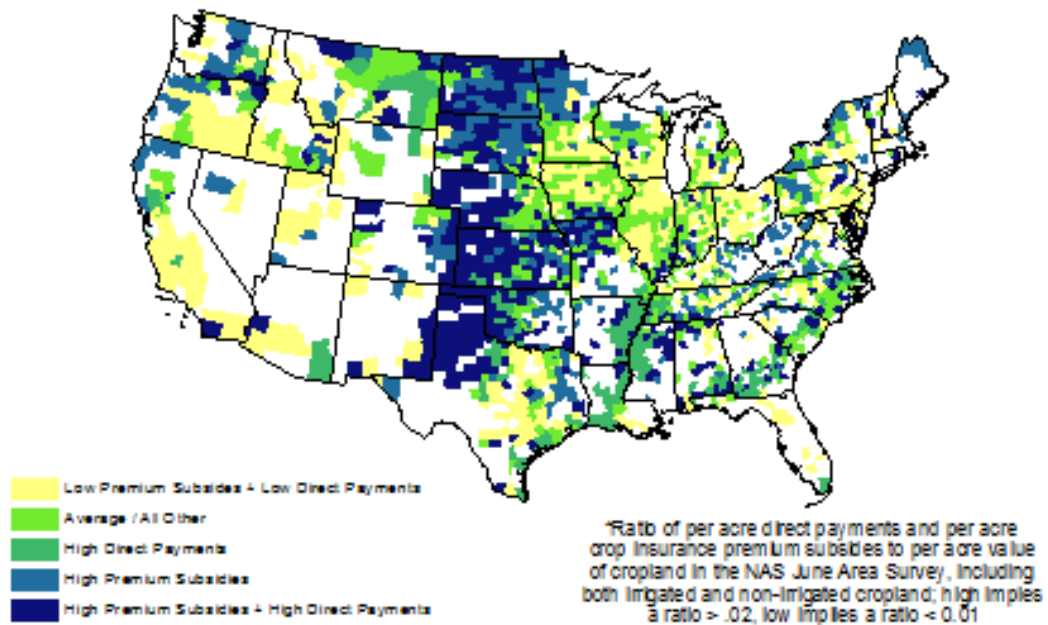

Empirical Model

- Fixed effects panel (standard errors clustered at the county level, survey weights used)
- Controls:
 - Insurance premium subsidies & indemnities
 - Returns (sales less production expenses) for previous 5 years (BEA)
 - Population Growth (BEA)
 - Population: Farm Acres (BEA, Ag Census)
 - Time



Our control variables follow Goodwin et al. (2011).

Government Payments

- Land values reflect expectations about future streams of income, including government payments
 - Based on past outcomes (observed) as well as unobserved factors
- Aggregated vs. disaggregated average program payments over the previous 3 years
 - Direct, environmental payments likely more closely matched to actual expectations



Our measure of government payments is the average of payments over the previous 3 years. This is done as a proxy for actual expectations of government payments.

Findings

	Values				Rents			
Returns	0.77	**	0.67	*	0.02	***	0.02	
All Payments	-1.00				0.00			
Misc.			11.33	***			0.054	
Disaster			-6.73				0.173	***
Coupled			-5.52	***			-0.05	**
Decoupled			32.35	**			0.221	

Program payments are an average of previous three years, returns are an average of previous 5 years



Coefficients can be interpreted as the change in farmland values for a \$1 change in the variable.

Going Forward

- Tie to June Area Survey point data to other administrative data
- Determine best measure for payment expectations
- Try to disentangle incidence between land owners and renters

ERS 

Appendix

ERS 

Summary Statistics

Variable	Mean	St. Dev
Cropland Value - Non-Irrigated (\$/acre)	2676	2500
Cropland Rent - Non-Irrigated (\$/acre)	74	47
Total Government Payments* (\$/acre farmland)	22	19
Coupled Payments*: Countercyclical, LDP, Market Assistance (\$/acre farmland)	6.92	9.95
Decoupled Payments*: Production Flexibility, Direct Payments (\$/acre farmland)	9.06	8.15
Disaster Payments*: (\$/acre farmland)	1.80	2.55
Other Payments*: Conservation, Misc programs (\$/acre farmland)	4.22	6.10
Premium Subsidy: Crop insurance premium subsidy (\$/acre)	17	19
Indemnity: Crop insurance indemnity (\$/acre)	28	79
Market Returns*: Average sales & marketing less production expenses (\$/acre farmland)	446	557
Population Growth*: Annual population growth rate (% change year t-1 to t)	0.15%	1.55%
Population: Farm Area*: Ratio of county population to farm acres	0.36	2.18

*County Level Variable

Note: All summary statistics are unweighted

Years = 2002-2009



County level: average for all JAS farms w/total land size >50 acres.

Rent/Value: Outliers dropped from the analysis are excluded.

References

- Goodwin, B., Mishra, A. and Ortalo-Magné, F. "The Buck Stops Where? The Distribution of Agricultural Subsidies" 2011, NBER Working Paper Series 16693 - <http://www.nber.org/papers/w16693>
- Latruffe, L and Le Mouél, C. "Capitalisation of Government Support in Agricultural Land Prices: What Do We Know?" 2009, Journal of Economic Surveys 23:4

7.1 References

Goodwin, B., A. Mishra and F. Ortalo-Magné, *The Buck stops where? The distribution of agricultural subsidies*. NBER Working Paper series 16693, 2011.

Latruffe, L. and C. Le Mouél, 'Capitalisation of government support in agricultural land prices: What do we know?' In: *Journal of Economics Surveys* 23 (2009) 4.

8 Working group session 1: FADN and the financial crises

The global financial crises has resulted in a situation of severe public deficits and government debts.

There is a huge pressure to implement budget cuts in all public expenditures.

This situation of budget cuts could also put pressure on the available budgets for FADN.

Discuss in your group the extent to which FADN in your country is now or in the near future confronted with budget cuts. Define and discuss strategies to prevent such budget cuts, and if they occur, how to implement such budget cuts. Strategies can range from increasing the value of the data being collected to strategies to reduce the costs of data collection.

Please report on the:

- Extent to which the financial crises have affected available budgets for FADN;
- Implemented or potential strategies to deal with (the threat of) budget cuts.

8.1 Results

Participants were asked to discuss in smaller groups the extent to which the financial crises in their respective country have affected current or future budgets for FADN. They were asked to define and discuss strategies to prevent such budget cuts, and if they occur, how to implement such cuts.

8.2 Extent to which the financial crises have affected current or future budgets for FADN

Prospect of budget cuts is on-going (will sustain in future), common to all and is a global issue. Method of FADN data collection and level of development is very heterogeneous among EU country members and non EU countries. First reaction is that FADN data is obligatory to collect, you can't cut? But this is likely to occur.

At the moment, there are no big budget cuts for most countries. The situation differs among participants:

- In the long term, there can be budget cuts (from advisory service budget to higher collection costs - Croatia);
- Need to increase sample, while facing annual budget cuts (Croatia, Finland);
- Potential 10-20% cut to research budget (USA);
- Budget cuts of 1/3 (UK);
- No big problems about budget at the moment and expect a cut of 3% (Norway);
- Budget reduced continuously (Norway);
- No imminent budget cut (Germany, Estonia);
- More money needed (Switzerland);
- Cut in IT expenditure is likely (EU-Commission);
- Large cuts(50%) could not be sustained, 25% more realistic.

8.3 Define and discuss strategies to prevent such budget cuts

- Know more about information and advice provided and needed.
- Know more about the magnitude of budget cuts.
- Know more about current data collection to identify where it is possible to cut.

- Show relevance and uses, Increase awareness and visibility (present value of research to farmers, senior officials, policy makers). Find new ways to use data, analyse it and disseminate information Examples: performance benchmarks for farmers, write articles in monthly rural magazines with FADN data
- Increase use (value added) of collected data.
- Ease access to academic (free data for greater use).
- Integrating new policy maker requirements (piggy-back on FADN surveys).
- Promote and motivate survey participant (find argument to answer following question by farmers: What is in it for me?)
- Promote data to potentially new users (industry, bankers, advisory services ...)
- Need to demonstrate usefulness by costs benefit analysis (budget for direct payments).
- Demonstrate potential impact of less data quality due to cutting budget.

8.4 Define measures to implement budget cuts

- Find way to improve efficiency of data collection.
- Define current work of data collectors/surveyors, analysts and expand if possible their duties.
- Integrate FADN data collection with other activities. Example in Kosovo: Ministry of Rural Development advisers who are very knowledgeable and 'locally connected' conduct survey (marginal additional cost).
- Seek efficiencies with it technologies (data collection, transfer to head office through internet, open source softwares ...).
- Outsource to develop booking software to meet FADN standards.
- Ask farmers to send data directly through internet survey mainly bigger farms (with quality checks).
- Promote use of book keeping.
- Acquire data from accountant firms and/or suppliers (or others) for fees.
- Link databases to ask information only one place/time (subsidies data ...).
- No compromise good and realistic quality.
- Create panel to participate to survey (give benchmark ...) as they become more knowledgeable and proficient to provide data year after year.
- Decrease collection of non-essential data, sometimes a lot of them are not used by the researchers.
- Move to ad hoc survey modules as needed.
- Not sure if cutting content (additional non-FADN requirements) will reduce costs significantly as surveyors have already incurred most costs (travel...) for collecting FADN required data.
- Develop cost recovery for data users, data are free now so one solution could be to establish a user fee.
- Get private companies sponsorship for collecting data they are interested in ...
- More electronic data collection (to reduce labour).
- Reduce the sample size. Will not be able to increase sample size and additional data requirements.
- Reduce frequency (not annual for all variables).
- Creating connections/linkage with other databases (suppliers, processors ...). This will also improve potential for research.
- No upgrading of infrastructure, building, computers, etc.
- Reduce administrative budget (staff cuts?).
- Cuts will be concentrated on travel and training, attrition (offer early retirement but not replacing retired staff), protect data collection as much as possible.
- Increase access to all existing registers (legal base), increase use of administrative data.
- Currently manage costs by not outsourcing (other than IT).
- Reduce payment to farmers but provide alternative incentives to provide data (very current data feedback/benchmark statistics).

- Simplify or adjust EU regulations and implement measures to harmonize definitions and methods.
- Harmonization of definition and methods.
- Common development IT system (EU/Group of countries).
- Ease legal access to registers to be able to draw more efficient sample or to link databases or create data warehouse for all the information related to agricultural statistics.
- Increase use of administrative data.

9 Balancing emerging data needs, preserving the core statistical program and controlling response burden and budgets: a utopia?

Martin Beaulieu

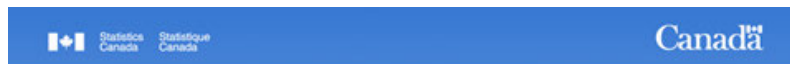

Canada

Balancing emerging data needs, preserving the core statistical program and controlling response burden and budgets: a utopia?

**Martin Beaulieu
Pacioli 19 Workshop
October 3rd 2011
Tallinn, Estonia**



Canada

Outline

- Background
- Program Review key considerations
- User needs
- Assessment criteria
- Approaches to reduce burden-costs
- Conclusion

Background

- Review of the Canadian Agriculture Statistics Program: including the Census of Agriculture (CEAG), surveys, remote sensing and administrative data
- Key drivers
 - Response burden “To wrestle burden to the ground...”
 - Corporate Business Architecture (CBA)
 - Government request to review Statistics Canada’s Census programs
 - Budgetary pressures

3

12/01/2012

Key considerations

- National Accounts
- Fed-prov legislation, policy & programs, benchmarks
- Key users (governments, industry, academics)
- International reporting (trade, environment)
- Small area data & Up-to-date Survey Frame
- Support cost-recovery, respond emerging needs
- Maximum use of administrative data & linkages
- Use of new technology (remote sensing)
- Efficient use of resources (budget reduction)
- Response burden
- Time to implement

4

12/01/2012

User needs - consultation

- Federal-Provincial-Territorial Committee on Agricultural Statistics
- Advisory Committee on Agriculture Statistics and key federal stakeholders
- Ongoing consultation with internal and external users
- North American Tripartite Committee on Agricultural Statistics
- Australian Bureau of Statistics
- Consultations with France, England and the Netherlands
- User and uses survey
- Business Survey Methods Technical Committee
- Advisory Committee on Statistical Methods

5

12/01/2012

User needs

- Building a case for agriculture statistics
 - Agriculture alone less than 2% of GDP but almost half domestic of production used as inputs into food manufacturing
 - Including food, about 10% of GDP
 - Food employs about 13% of working population
 - \$155 billion domestic spending
 - \$39 billion of exports
 - 7% of land (up to 44% in some provinces)
 - \$8.4 billion fed-prov support – 34% sector GDP

6

12/01/2012

User needs – Defining the core

- Looking beyond legislative needs

Non-core

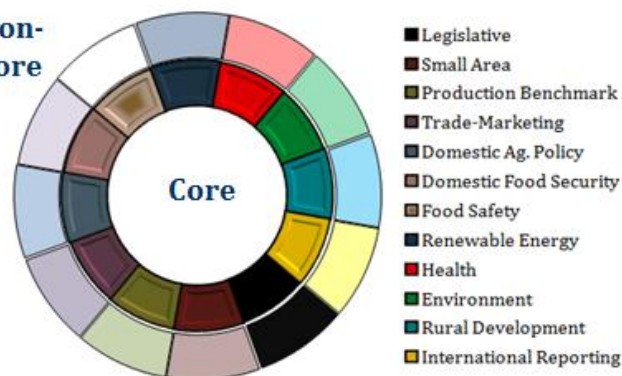

7

12/01/2012

Emerging needs

- Organic
- Local/farm direct marketing
- Aquaculture farming practices
- Monitoring food security & supply
- Environmental sustainability
- Energy use and renewable sources
- Food safety
- Irrigation and water use
- Farming household activities (farm & non-farm)
- Foreign ownership...

8

12/01/2012

Long-term needs

- "To feed a world population expected to reach more than 9 billion in 2050, it is estimated that agricultural production will have to increase by 70 percent over the same period, and more specifically by almost 100 percent in developing countries."

Meeting of G20 Agriculture Ministers, Ministerial Declaration 'Action Plan on Food Price Volatility and Agriculture', Paris, June 22-23, 2011

8

12/01/2012

Assessment criteria

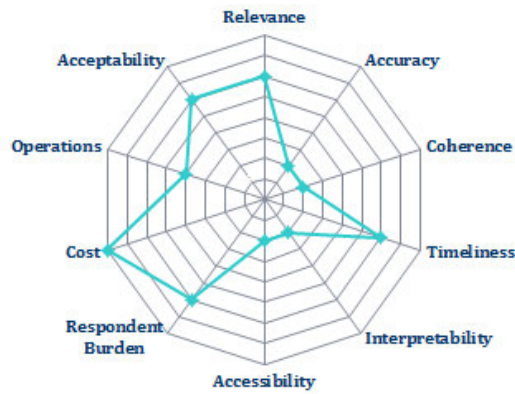

10

12/01/2012

Cost - burden

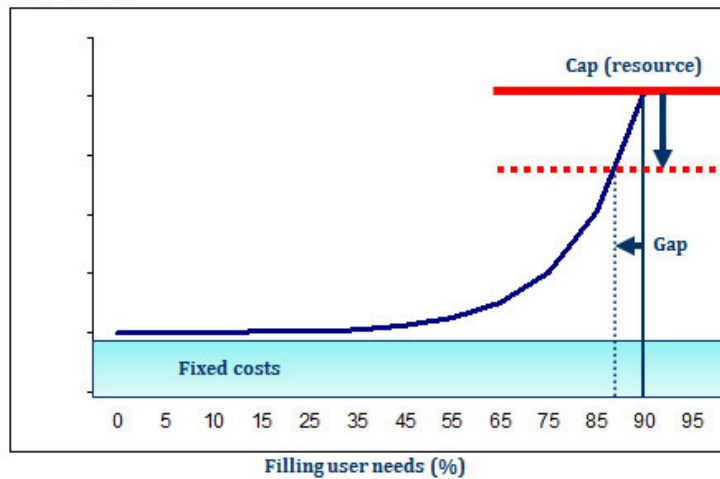

Cost-burden

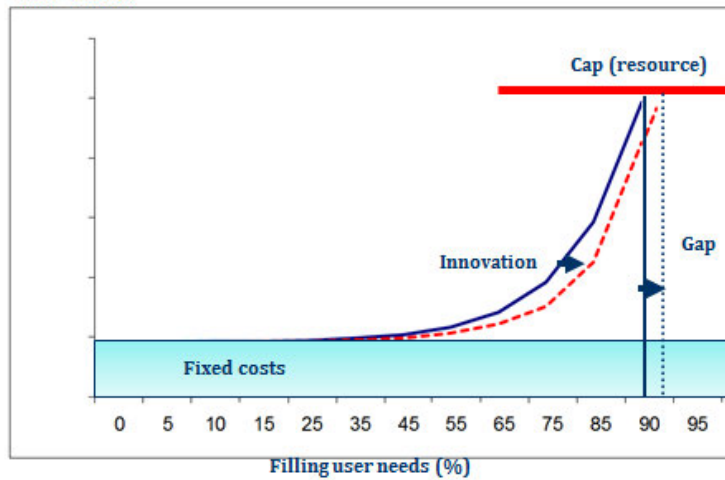

Approaches to reduce burden-costs

- Back to the Core – reduce content
- Cap on calls/contacts
- Multi-modal data collection
- Integrate alternative data sources
 - Agriculture programs
 - Taxation data replacement
 - Commercial data (supplier invoices...)
 - Farm accounting data
 - Model data (micro-simulation...)

Approaches to reduce burden-costs

- Survey sampling efficiency
- Rolling estimate (collecting data until reach x% specific variables)
- Control sample overlap between surveys
- Reduce survey sub-annual frequency
- Adapt content (short-long form) to sub-groups
- Changes to target and/or survey population

Approaches to reduce burden-costs

- Canadian target population: “all operations producing agriculture products with the intent of selling them”
 - No minimum sales or size requirement
- Census of Agriculture collects information on all operations in the target population
- Surveys: threshold of 10k \$Can with/without adjustment to represent units under thresholds

16

12/01/2012

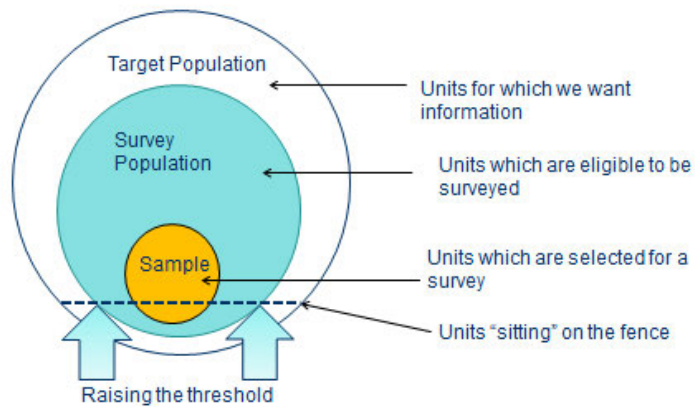

16

12/01/2012

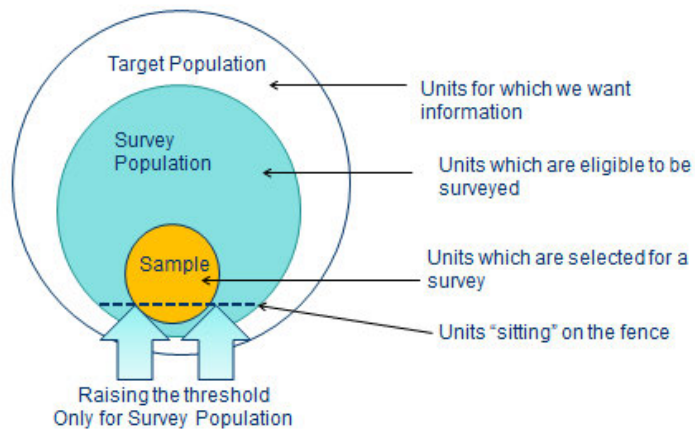

17

12/01/2012

Target Population % farms under threshold

Sales Cut-off	Farm count	Sales	Veg Area	Fruit Area	Crops Area	# Cattle	# Sheep	# Pigs
< 1000	1.78	0.00	0.00	0.02	0.01	0.00	0.05	0.00
< 5000	9.04	0.11	0.19	0.64	0.25	0.09	1.56	0.01
< 10000	15.07	0.46	0.60	2.20	0.95	0.41	4.40	0.03
< 20000	28.02	1.64	1.56	6.10	2.98	1.78	11.25	0.07
< 30000	37.47	3.08	2.67	9.96	5.23	3.86	18.56	0.12
< 40000	44.43	4.56	3.59	13.63	7.55	6.17	25.69	0.18
< 50000	49.61	5.99	4.72	16.91	9.76	8.64	32.00	0.24

18

Approaches to reduce burden-costs

- New technologies
 - Remote sensing for modelling crop production, area and yield
 - Precision Agriculture
- Developing new administrative sources
 - Change of culture – Clearing House
 - Data requirements built-into new programs
- Others?....

19

12/01/2012

Questions for discussion

- Balancing emerging data needs, preserving the core statistical program and controlling response burden and budgets: a utopia?
- Other approaches to be investigated?

martin.beaulieu@statcan.gc.ca

20

12/01/2012

10 Policy analysis based on micro-economic data conducted at JRC-IPTS Agrilife Unit and Future data needs. Selected activities

M. Espinosa (presenter), S. Gomez y Paloma and P. Ciaian



Policy analysis based on micro-economic data conducted at JRC-IPTS Agrilife Unit and Future data needs. Selected activities

M. Espinosa (presenter), S. Gomez y Paloma, P. Ciaian

**19th PACIOLI Workshop
Tallin (Estonia), Sept. 3th-5th October, 2011**



Content

- I. Introduction: JRC-IPTS
- II. FADN data use
 - SPS Capitalization into Land Values
 - Farm level modeling (CAPRI-FARM)
 - Modelling farm structural change
 - FP VII project FADNTOOL
- III. Data needs to be included/improved in FADN in order to conduct impact analysis



- JRC-IPTS provides **techno-economic analysis** in support of the EU policy-making process.
- One of the key area is providing scientific support on the impact analysis for the **CAP conducted** in the Agri-life Unit (AGRI-TECH, AGRI-TRADE, SUSTAG actions)
- **Key approaches for policy impact analysis used in the Agri-life Unit:**
 - **Market level modeling** (e.g. EU, MS, regional level)
 - **Farm modeling**
 - **Micro-analysis and case-studies**
- **Selected ongoing IPTS project built on FADN:**
 - SPS Capitalization into Land Values
 - Farm level modeling (CAPRI-FARM)
 - Modelling farm structural change
 - FP VII project FADNT00L

ipts

AGRITECH: New Technologies in Agriculture - their agronomic and socio-economic impact

AGRITRADE: Support to Agricultural Trade and Market Policies

SUSTAG: Sustainable Agriculture and Rural Development: the socio-economic dimension

Introduction/Objective

- **Land capitalization of subsidies has been studied extensively in the literature.**
- Theoretical models show that landowners appear to benefit disproportionately more than other agents **due to the inelastic land supply**
- **However, there is no robust evidence** on the exact capitalization rate for different types of agricultural policy instruments.
 - The capitalization rate of *coupled* subsidies varies between 20% and 100%.
 - The capitalization rate of *decoupled* subsidies varies between 20% and 80%.
- **The objective of the research is to assess** the capitalization of the Single Payment Scheme (SPS) into land rental prices **in the EU.**

ipts

The SPS was introduced by the 2003 CAP reform and it was implemented starting from 2005. Under the SPS farm subsidies depend on the on the number of the SPS entitlements and the eligible hectares.

Each farm in the EU was allocated a fixed amount of SPS entitlements which can be increased or decreased through trade.

The SPS is linked to land, because in the absence of land farms cannot cash in the SPS entitlements. Farms can activate SPS entitlements and receive the SPS payments, if they are accompanied by an equal number of eligible hectares.

Theoretical analysis

- **The relation between the SPS and land rents is non-linear:**
 - The entitlements stock effect and credit market imperfections *increase* the capitalization rate of the SPS, whereas the cross-compliance, the tradability of entitlements and land market institutions and regulations *reduce* the capitalization rate of the SPS. Hence the overall effect is ambiguous
- **The relation between the SPS and land rents is discontinuous:**
 - Higher value SPS entitlements are capitalized at different rate than lower value entitlements.

ipt

Estimation Approach

- **We employ generalized propensity score (GPS) matching (Hirano and Imbens 2004; Bia and Mattei 2008).**
- **Standard regression may lead to biased results as it may fail to control for the econometric issues (selection bias and endogeneity) and nonlinear effects.**

ipt

Farms' choice of past production structure determined the level of coupled subsidies in the past and determines the level of the SPS now.

Farms which produced more supported commodities received more SPS per hectare.

Given that the choice of production structure was not random but dependent on farm characteristics farms may have selected themselves into a given level of the SPS intensity.

SPS payments are not assigned randomly to farms but are endogenous, because they depend on region and farm productivity levels.

The SPS is upward biased toward more productive regions.

In the past, the coupled subsidies were dependent on the regional and farm productivity levels. Farms located in more productive regions received higher coupled subsidies than farms located in less productive regions.

The new decoupled SPS were allocated based on the value of past coupled subsidies. Hence SPS and land rental prices are positively correlated.

Data

- We use Farm Accountancy Data Network (FADN) farm level data (19000 farms) for 15 EU countries for 2004 and 2007.
- The choice of the period 2004-2007 was determined by the availability of data and to cover the period before (i.e. 2004) and few years after (i.e. 2007) the introduction of the SPS.
- Dependent variable: a difference in farmland rental rate between 2004 and 2007.
- Treatment variable (T): per hectare SPS (In 2007 the SPS accounted for 53% of all the EU subsidies).
- Farm-level covariates ($X1$ to $X10$):
 - > $X1$ - UAA area per family labor,
 - > $X2$ - economic size per family labor,
 - > $X3$ - total output per family labor,
 - > $X4$ - gross farm income per family labor,
 - > $X5$ - total liabilities per family labor,
 - > $X6$ - the ratio of total subsidies to gross farm income,
 - > $X7$ - the ratio of subsidies on investment to net investment,
 - > $X8$ - the ratio of coupled subsidies to gross investment,
 - > $X9$ - land entitlements per family labor and
 - > $X10$ - the ratio of rented land to UAA.



The selection of covariates was made based on consideration of economic theory and presumption that these should be the most crucial variables determining both outcome as well as the intensity of SPS support.

Selection bias occurs when the treatment condition (e.g., experimental vs. control) of a participant is not independent of confounding covariates which are also correlated with the outcome.

Results

Capitalization rate of the SPS into land rents

Treatment level (SPS/ha)	Average dose response (change in rent) (Eur/ha)	Marginal capitalization	Average capitalization
(1)	(2)	(3)	(4)
0	-23.09		
50	5.95	0.58	0.58
100	-10.18	-0.32	0.13
150	-4.93	0.11	0.12
200	-0.12	0.10	0.12
250	-0.27	0.00	0.09
300	-3.02	-0.06	0.07
350	-6.09	-0.06	0.05
400	-8.33	-0.04	0.04
450	-9.41	-0.02	0.03
499	-9.42	0.00	0.03

Results

- For SPS smaller than 200 EUR/ha, the capitalization rate varies between 12% and 58%.
- For SPS payments larger than 200 EUR/ha, the capitalization rate is much lower, between 1% and 9%.
- The weighted average capitalization rate for EU-15 is 6 percent.
- Our estimates are lower than estimates on decoupled payments in the US, according to which the capitalization rate of decoupled subsidies varies between 20% and 80% (Goodwin, Mishra and Ortalo-Magné 2003, 2005; Lence and Mishra 2003).
 - Though our results are theoretically consistent, the lower estimated capitalization for the EU could be due to the rigidity of rental markets, which may be induced by rigid land market institutions and regulations.

ipts

Farms possessing low value SPS payments channel a bigger share of the SPS to landowners through higher land rents than other farms.

What is CAPRI-FARM?

- CAPRI-FARM is a module developed within the CAPRI (CAP Regionalized Impact) modeling framework.
- CAPRI FARM is farm type level (partial equilibrium) model used for simulating CAP impact at farm type level.
- Recent application: EU-wide Distributional Effects of EU Direct Payments Harmonization and Farm level impacts of trade liberalization.
 - Gocht, A., Britz, W., Adenäuer, M. (authors), Ciaian, P. and Gomez y Paloma S. (eds.). (2011) "Farm level policy scenario analysis." JRC Reports, EC JRC, EUR 24787 EN.
<http://ftp.jrc.es/EURdoc/JRC64334.pdf>

ipts

Data

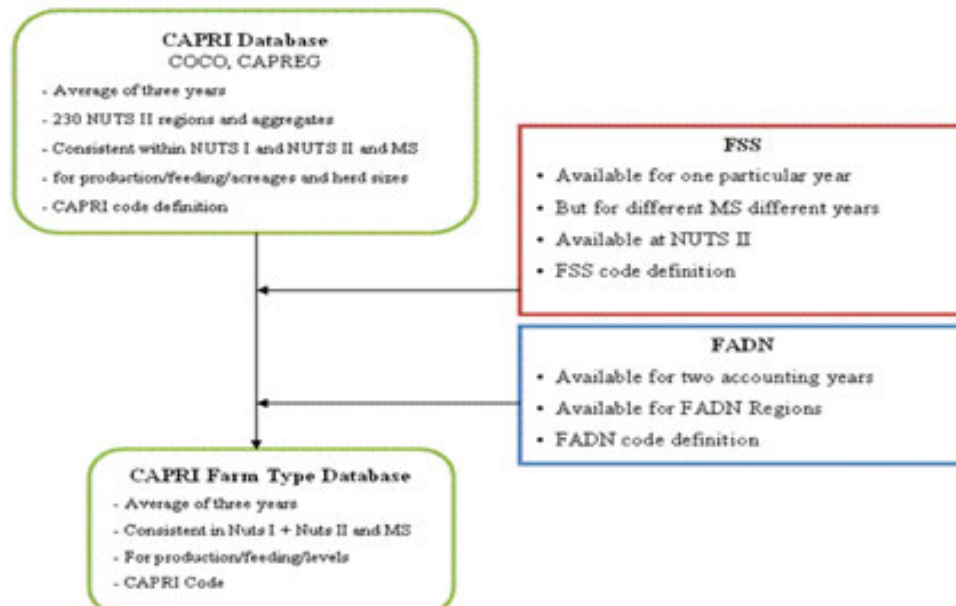

pts

Data

- FSS is used to create farm type layer in the CAPRI-FARM module.
- Farm types are distinguished along two dimensions:
 - FSS Principal Types of Farming (TF).
 - Farm size represented in terms of "European Size Units" (ESU)
- The module distinguishes 14 Types of Farming (including residual one) and 3 farm sizes (<16 ESU, 16-100 ESU, >100ESU).
- Out of 3x14 potential farm classes, in each Nuts2 region, max. 9 most important farm types (based on UAA and LSU) plus a residual farm type are selected.
- FADN is used to supplement data from FSS for economic production coefficients (i.e. prices, yields or input use).

ips

The CAPRI-FRAM module considers in each Nuts2 region, a maximum nine the most important farm types plus a residual farm type altogether representing total regional production as well as input and primary factor use. Each single farm type is characterized along two dimensions given by Types of Farming (production specialization) and the 'economic size class' represented in terms of 'European size units' (ESU). We consider 13 Types of Farming and 3 farm sizes. The choice of Types of Farming and farm size classes is a compromise between model complexity, robustness of the result, reporting limitations and data constraints. A higher farm disaggregation, would increase complexity of the module without adding value in terms robustness of the modelling results. Similar arguments hold for our choice of the three economic farm size classes (ESC), defined as ESC 1 with less than 16 ESU, ESC 2 with ESU between 16 and 100, and ESC 3 with more than 100 ESU. In total, this leads to 39 farm types (=13*3) defined by Types of Farming (production specialization) and farm size. From these possible set of 39 farm types, maximum 9 most important farms are selected in each Nuts2 region. The farm selection is based on two criteria: Livestock Units (LU) and Utilised Agricultural Area (UAA). Both criteria were given equal priority (equal weights) in determining the importance of farm types. The restriction to maximal ten farm groups (the 9 most important ones plus the residual farm) per region is based on storage and computing time considerations, but also by the aim to keep database and model outputs at a manageable size for quality control and result analysis.

- **Objective:**
 - Analyze the farm structural change (SC) using FSS / FADN databases (and other potential data-sources (e.g. Eurostat, DeStatis,..) with variables that may explain structural change including CAP related issues) = Ex-post analysis
 - Incorporate the data obtained in the ex-post analysis related to the projection of number of farms (year 2020) in the CAPRI-FARM model = Ex-ante analysis.
- **Prototype tool** tested in the entire Germany to describe the SC and in 2 NUTS-1 to determine the factors affecting the SC (project results by early 2012)

ipts

- **Structural change is defined as:**
 - DISCRETE: change in farm typologies (general type of farming or principal type of farming to be decided), farm entry/exit and change in size (Economic Size Units: 16-<40 ESU; 40-<100 ESU and >100 ESU). Data used: FADN/FSS
 - CONTINUOUS: change in the share of a group of activities (P1-P5) on the overall production: Data used: FADN/FSS

ipts

EX-POST ANALYSIS

- Calculate the transition probabilities (TP) (Markov approach) between T. Farming and ESU using FADN micro-data and FSS micro-data in Germany.
 - **Quality check** comparing 2007 FSS reported data with:
 - 2007 FADN estimations based on 1989-2003
 - 2007 FSS estimations based on 1999-2003
 - **Estimate** complete time series to the year 2020
- Estimate the continuous SC on farm typologies based on the methodology of the **Manhattan Block** distance (sum of distances along each dimension = group of activities) in Germany
- Determine the factors defining structural change in two NUTS-1 regions: The determinants affecting the continuous and the discrete SC will be estimated and compared e.g. (inputprices, outputprices, Pillar 1 payments, Pillar 2 payments,...)

ipts

Manhattan distance: this distance measurement is especially relevant for discrete data sets. While the **Euclidean distance** corresponds to the length of the shortest path between two samples (i.e. 'as the crow flies'), the Manhattan distance refers to the **sum of distances** along each dimension (i.e. 'walking round the block').

EX-ANTE ANALYSIS: Make simulations related to different policy scenarios with the model CAPRI-FARM

- The CAPRI (-FARM) baseline (2004-2020) serves as a reference point for ex-ante impact analysis
- It reflects the most probable development in agriculture
- The baseline in CAPRI model is built at NUTS-2 level (AGLINK, FAO, IFPRI,... And expert knowledge)
- Current **CAPRI-FARM** baseline breaks land use/yields/technological coefficient changes from NUTS-2 proportionally down to farm types based on the base year data (2004)
 - at present there is no time series data available for farm type production structures and evolution
- The model **CAPRI-FARM** will be improved by incorporating in the baseline the projections of the number of farms derived from the estimated trends in the ex-post analysis.

ipts

Objective: Integrating Econometric and Mathematical Programming Models into an Amendable Policy and Market Analysis Tool using FADN Database

Dates: May 2011/May 2014

Project Partners:

NO	NAME	COUNTRY
1	ARISTOTELIO PANEPISTIRIO THESSALONIKIS	Greece
2	UNIVERSITE DE PERPIGNAN	France
3	WAGENINGEN UNIVERSITEIT	Netherlands
4	UNIVERSITY OF MACEDONIA ECONOMIC AND SOCIAL SCIENCES	Greece
5	UNIVERSITY OF CYPRUS	Cyprus
6	UNIVERSITAET BONN	Germany
7	JOHANN HEINRICH VON THUENEN-INSTITUT	Germany
8	SVERIGES LANTBRUKSUNIVERSITET	Sweden
9	TIC UNIVERSITY OF WARWICK	United Kingdom
10	SZKOŁA GŁÓWNA GOSPODARSTWA WIEJSKIEGO	Poland
11	UNIVERSITY OF NATIONAL AND WORLD ECONOMY	Bulgaria
12	UNIVERSITA CATTOLICA DEL SACRO CUORE	Italy
13	JRC - JOINT RESEARCH CENTRE - EUROPEAN COMMISSION	Belgium

ipts

Future data needs on the model CAPRI-FARM:

- At present the complete FSS census is every ten year. More frequency in order to have an accurate estimation (ex-post) and simulation (ex-ante) of the Transition Probabilities in the assessment of structural change.
 - Ideal frequency is each year, for the following variables: UAA/LU per activity in order to build the Farm Type Baseline.

- Update the past data to the new farm typologies based on Standard Output (SO) (to be used from 2010) to have a consistency in the complete time series among farm typologies (this exercise will require as well an estimations of the SO for the past data). This exercise is needed as well to adapt the FADN weights in the time series.

ipts

Work packages

- WP1 Review of Existing Approaches in the Use of FADN Data for Modelling
- WP2 Aggregation of the Supply Response Models to the Regional, National, and the EU Level
- WP3 Development of A Dual Econometric Model Analyzing Farmers' Economic Behaviour
- WP4 Development of Farm Optimization Models Analyzing Farmers' Economic Behavior and Structural Changes
- WP6 Novel DEA Models for the Assessment of Efficiency of Farms and Elasticities of Sudo-Economic Factor
- WP8 Development of a Dual Econometric Model Analyzing the Impact of EU Policies on Land Prices
- WP7 Model Simulation and Policy Analysis
- WP8 Development of the GTAPMH CGE Model and Its Implementation for Impact Assessments on Farm Income
- WP9 Development of a User-Friendly Interface and a complete handbook for all models
- WP10 Demonstration and Dissemination of the Results
- WP11 Project Assessment and Monitoring
- WP12 Project Management

More info: <http://www.fadntool.eu>

ipts

- **Small farms** are NOT represented. Threshold:
 - 1 ESU : Bulgaria, Romania,... (2)
 - 2 ESU: Hungary, Poland, Portugal,...(10)
 - 4 ESU: Spain, Italy,...(3)
 - 8 ESU: France, Slovakia,...(9)
 - 16 ESU: Germany, UK...(4)

- **Importance of recording these farms as:**
 - In the Impact Assessment of the CAP it is foreseen an aid for small farmers (farmers receiving less than 1000 Euros in Direct payments and with a minimum size greater than 0.3 ha/1 ha depending on each MS)

ipts

Importance of better monitoring Pillar 2 and Art.69

- ❑ **Second pillar payments NOT very well disaggregated**
 - **Axis 1:** Only represented the use of advisory services, participation in food quality schemes and meeting standards.
 - **Axis 2:** Animal welfare payments and agri-environmental payments are aggregated (code 800), not included WFD payments.
 - **Axis 3:** Not represented at all. Just added as code 953 (grants and subsidies to rural development not included in the codes presented above)
- ❑ **Difficult to follow the track of Art.69.** At present it is under code 956, however in some cases it is as well included under code JC800 (agri-env+animal welfare), JC840 (support for quality). Proposal: Include Art.69 in Table J (either separated or included in the total amount of grant and subsidies) or only include it in code 956, therefore not mix with other variables.

ipts
DGP 21

Other data that will improve the econometric estimations

- ❑ **Quantities of fixed assets.** Under column G (100) it is just stated the value of the machinery and equipment.
 - ❑ Proposal: include the number of tractors and the value of other fixed assets : e.g. solar panels, wind mills to produce renewable energy.
- ❑ **Variable cost per crop.** At present in the FADN there is data (Table F) on costs for the different inputs aggregated for the total crop/livestock in the farm: e.g: seeds, fertilizers...
 - ❑ Proposal: Include the results (after validation) of the 7th FP FACEPA (disaggregates costs per crop using PMP approach) in the FADN databases.
- ❑ **GMO crops:** At present no data regarding whether the crop is GMO/not GMO (currently only approved in the EU GM crops: Bt maize and starch potato).
 - ❑ Proposal: Include a variable in order to identify GMO crops in order to better understand the drivers regarding the adoption of this technology.

ipts
DGP 22

Potential variables to include determining rural viability and understand farmers behaviour (1/2):

- ❑ **Social Capital:**
 - ❑ Micro-structural: belonging to cooperatives, farmers Union, env. Groups, where do you get the information relative to CAP?,
 - ❑ Micro-cognitive: Trust in your neighbours, local/national/EU administrations, active participation in consultation workshop,...
- ❑ **Intentions and attitudes:**
 - ❑ Management of the farm: Future of the farm when the main owner retires, intentions relative to different policies (e.g: CAP evolution, renewable energy, quality labeling schemes).
 - ❑ Farmer attitudes/knowledge: Scale pioneer-non pioneer farmer in adopting CAP policies, Knowledge level of different policies,

ipts
DGP 23

Potential variables to include determining rural viability and understand farmers behaviour (2/2):

□ Socio-demographic characteristics:

- Education: Include the level of general education
- Household composition: including age
- Off-farm income (amount), off-farm labour (AWU)

□ Transaction Costs: there is a growing body of literature dealing with the importance of TC, specially as a barrier for adoption of some voluntary AES, labeling schemes.

- Proposal: in Table C "labour" disaggregate the annual time worked (hours) devoted to get informed in the different CAP aids, filling the contract, ...

□ Importance of the short supply chain and quality labelling schemes
(special target in the CAP post 2013)

- Proposal: include variables: what is the % of direct sales?, what is it the production involved in food quality schemes regarding fresh products (PDO, PGI, TSG)?

ipts

Thanks for your attention

**M. Espinosa (presenter), S. Gomez y
Paloma, P. Ciaian**

e.mail: maria.espinosa@ec.europa.eu



ipts

11 Unpaid family labour analysis on FADN farms

Alina Sinisalo paper presented by Minna Väre

11.1 Introduction

During the past few decades, agricultural work has been highly mechanised and automated. Nevertheless, agriculture is a labour-intensive industry and therefore labour constitutes a remarkable part of costs. Labour and working time information are collected to study the importance of labour in an industry and are used in various economic key figures. Work time information is used in agricultural consultation services, research, legislation reforms and follow-up of effectiveness of politics. In addition, work time information is invaluable in resource estimation, for instance, in farms that plan to widen their operations. In Finland, work information from MTT Economic Research's (MTT) profitability bookkeeping farms is based on actual figures kept by farmers. Work information is available since early 1900s to the present. Every year more than 900 agricultural and horticultural farms are engaged in profitability bookkeeping. After weighting, the sample results are used to represent all Finnish farms exceeding a certain economic size. Weighting is based on the FSS, the Farm Structure Survey of Information Centre of the Ministry of Agriculture and Forestry of Finland (Tike).

In this article, the average farm family labour input for the years 1998-2009 is studied. The results are examined regionally and both weighted and non-weighted results are compared.

11.2 Factors affecting labour use and costs

The operation environment on farms is exceptionally diverse, and thus agriculture differs from many others industries. The work includes a wide range of tasks, for instance building work and machinery repair work in addition to crop and horticultural work and animal husbandry. The farm is also home and workplace. A summary of factors affecting labour use and costs is presented in Figure 11.1.

The needed work time varies between production lines. In general, the amount of work is greater on animal farms than on crop farms. On large farms, of course, the workload is greater than on small farms. As farm size increases, the total amount of work per hectare or per animal, however, is reduced. The diversity and complexity of a work task increase the needed time. Also the reliability of machinery and equipment plays an important role. The skills and work experience of workers can either increase or decrease the needed work time. Furthermore, their commitment and motivation are important. Accidents and disturbances in production processes increase work time and, at the worst, production may be suspended. With good planning, work tasks can be set in proper order and suitable workers can be chosen. For unexpected circumstances it is good to have a backup plan.

Figure 11.1 Factors influencing the needed working hours



The labour is an important part of costs in agriculture. In 2010 the production costs of Finnish agriculture and horticulture totalled about € 7.2 milliard. After supplies expenses (€ 1.79 milliard) the second largest cost was farm family's own labour input (€ 1.51 milliard) and its share was about 21%. This would be the cost to the farmer, if the work had been done by hired labour. A decade ago the wage claim of farm family still accounted for about 25% of the total costs.

Figure 11.2 Specification of return and costs of Finnish agriculture and horticulture in 2010 (Niemi and Ahlstedt, 2011)

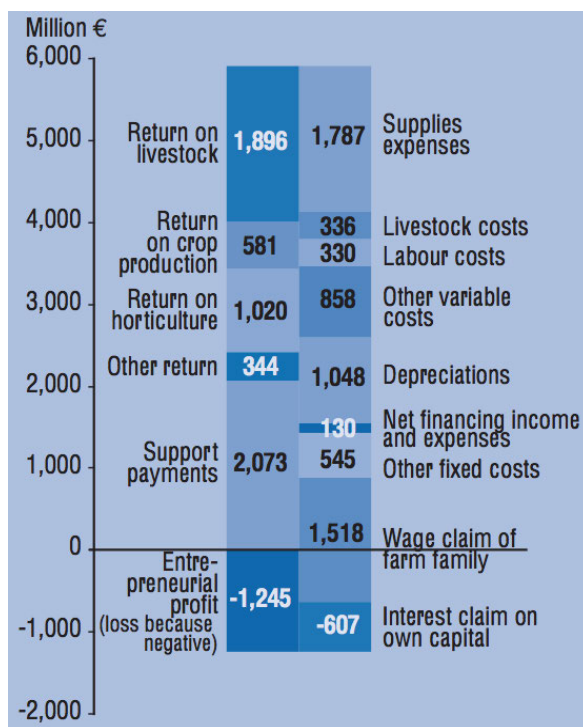

11.3 Data

MTT Agrifood Research Finland collects farm level profitability bookkeeping (FADN) data. Dataset includes more than 900 agricultural and horticultural farms. The results from sampling are weighted based on the Farm Structure Survey. Working hours are collected for workers individually. Different years' bookkeeping results can be compared because information collecting methods and compilations have not changed during the years.

Weighted profitability bookkeeping results for 1998-2009 from MTT economy doctor online service were used. Weighted average figures for work amount from the service for 1998-2009 covered about 40,000 farms. Only active farms with economic size more than 9,600 Euro are included in weighting. Weighting means that every farm in the sample represents several farms in population. Non-weighted farm-level data were from the years 1998 and 2009. Only unpaid labour hours in the agricultural work task were studied.

Figure 11.3 Finnish NUTS II regions



11.4 Regional study

Finland is divided into four regions (NUTS II) (Figure 11.3). In Finland NUTS II and FADN regions are not the same but in other EU member countries they can be the same.

The number of farms has decreased by 26 per cent (Figure 11.4). The average size of farms has increased as the number of small farms has decreased and, on the contrary, the number of large farms has increased (Niemi and Ahlstedt, 2011). The number of farmers has decreased year after year. The decrease in farm numbers has been greatest in eastern Finland, where which the decrease has been 27 per cent.

Figure 11.4 Number of farms by regions (Farm Register)

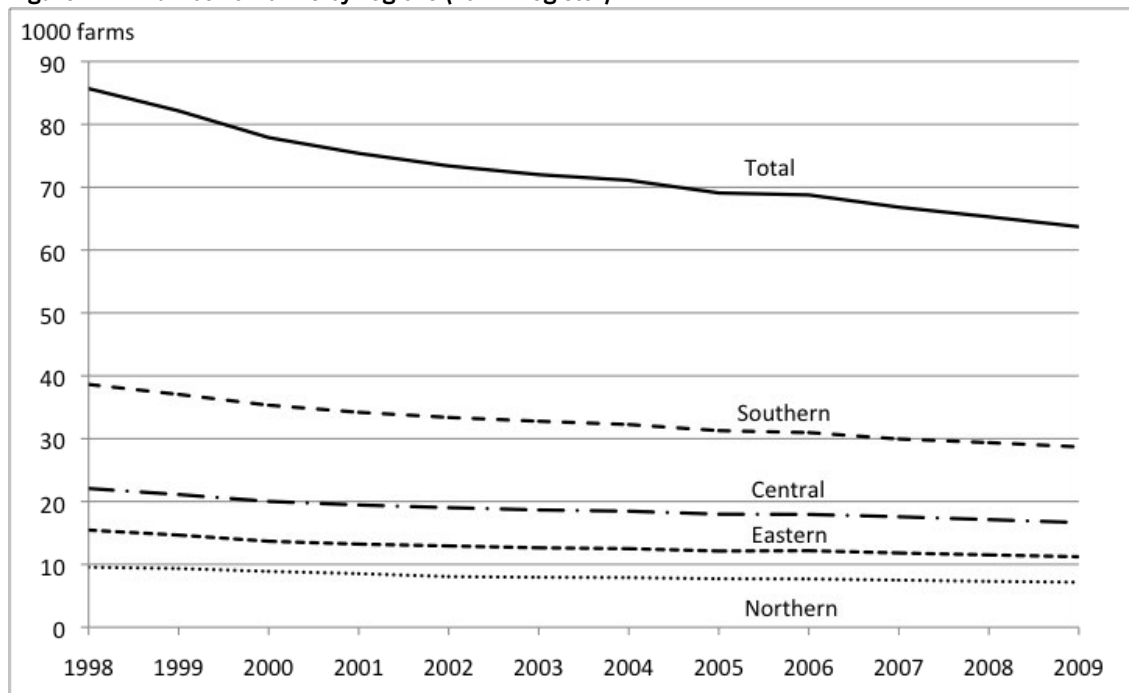

The average amount of working hours has decreased differently in different regions. The biggest relative decrease has been in central Finland (22%), followed by southern Finland (19%). The decrease has been the smallest in northern Finland (10%).

In eastern and northern Finland the average working hours of farm family is biggest (Figure 11.5). In 1998 farm family worked for 3,800 hours in north, whereas in south family worked for 2,750 hours. The farm family working hours have steadily declined in every area. In 2009, farm family worked only for less than 3,000 hours in north and less than 2,000 hours in south.

The average working hours for a farm varies a lot according to the type of production and farm size. In southern and central Finland the average farmland size is largest. The types of operations are also differently distributed between areas. In southern and central Finland there are many crop farms, in which work amount is smaller than in livestock farms. More than half of crop farms are in southern Finland and one fourth are in central Finland. In northern Finland most of the working hours are used in animal husbandry.

There is a great difference in distributions when weighted (Figure 11.6) and non-weighted results (Figure 11.7) are compared. Weighted results take better into account the structure of Finnish agriculture and, thus, smaller farms have greater significance. The farms that had high amount of working hours have smaller significance when results are weighted. Considering the number of farms, southern Finland farms are under represented in bookkeeping farm dataset. Under or over representativeness of farms can be problematic without weighting when results are generalised.

Figure 11.5 Average unpaid working hours for agriculture

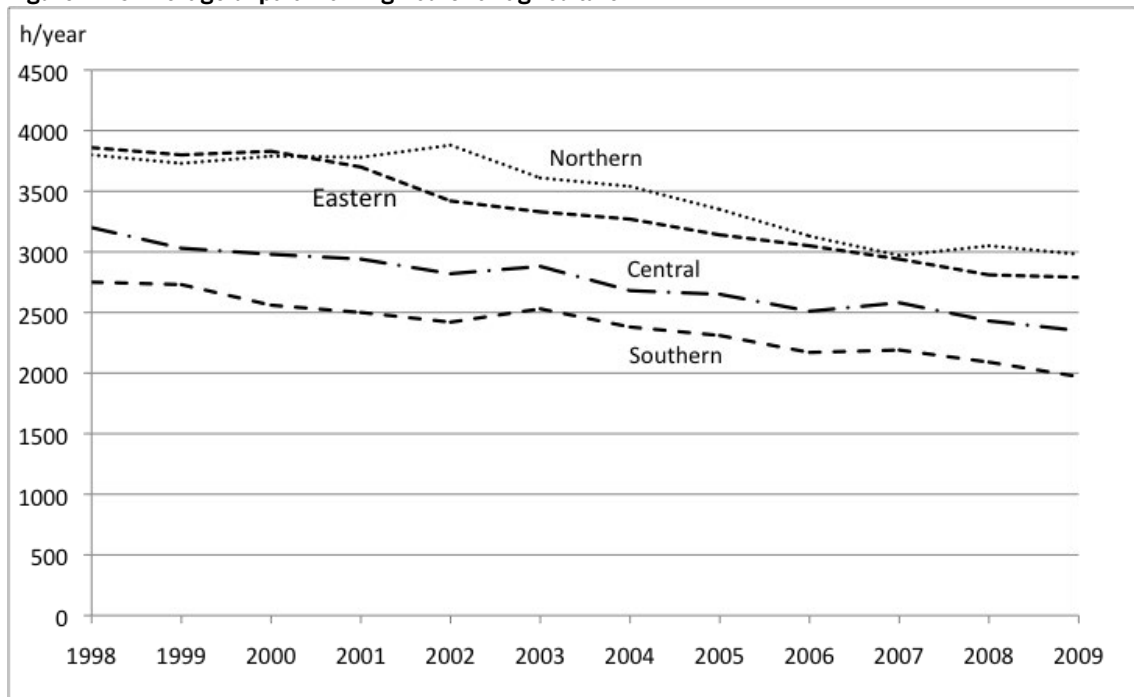

Figure 11.6 Distribution of unpaid working hours for agriculture, non-weighted cases

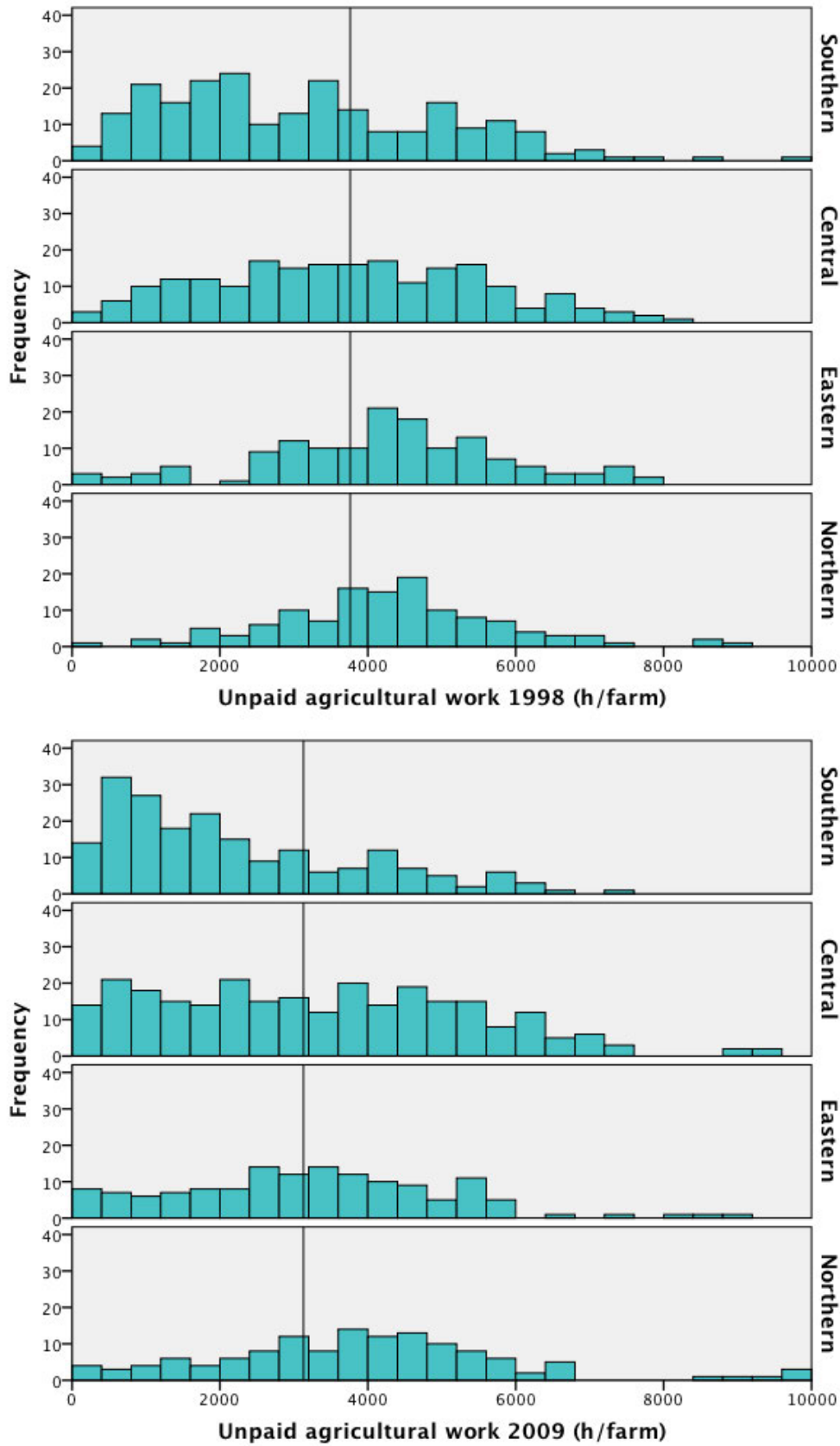
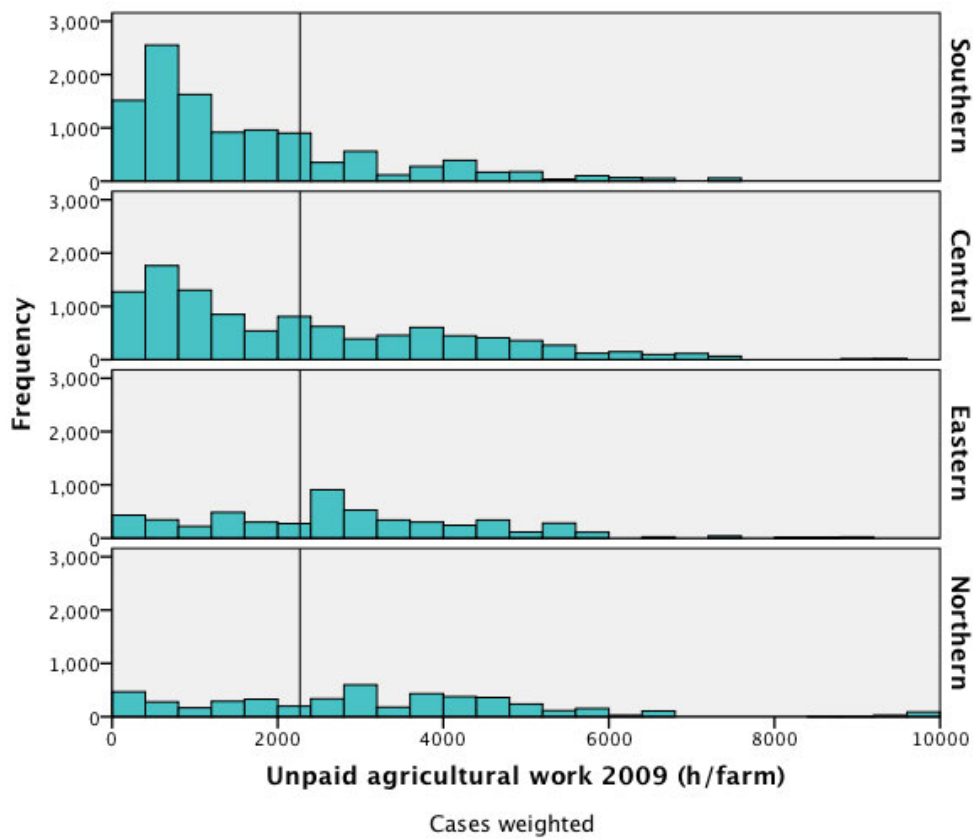
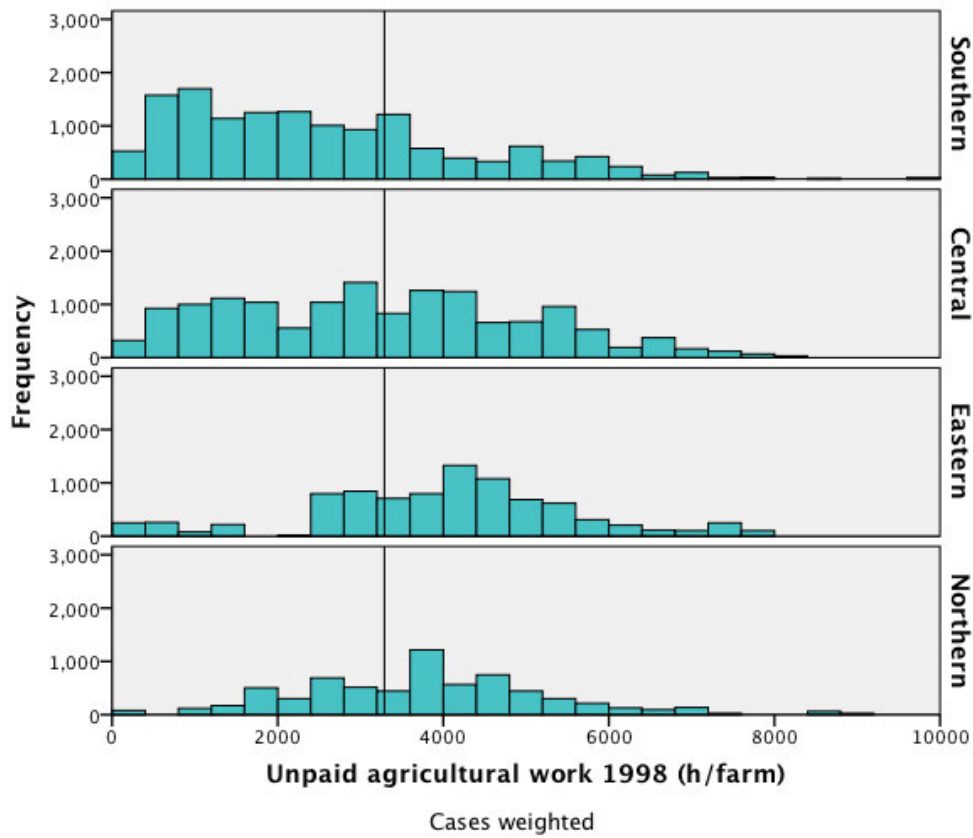

Figure 11.7 Distribution of unpaid working hours for agriculture, weighted cases



11.5 Conclusions

Labour input cost has an influence on various economic parameters. Paid labour input costs are obtained from bookkeeping. Because of the importance of labour costs, the collection of unpaid labour input information is also necessary. Weighted results take into account the structure of Finnish agriculture. If results are not weighted, the under or over representativeness of farms may be problematic for generalisation.

11.6 References

Information Centre of the Ministry of Agriculture and Forestry, *Farm Register*. Available at: <<http://www.mmmtike.fi/>>

MTT. Economy Doctor online service. Available at: <<http://www.mtt.fi/economydoctor/>>

Niemi, J. and J. Ahlstedt (eds), *Finnish Agriculture and Rural Industries*, 2011. 96 p.

12 Electronically transmission of data in Norwegian agricultural sector

Haukas Torbjorn and Kjell Staven

A concerted action for effective exchange of farm level data in Norway

12.1 Introduction

This paper follows up a paper presented at the 16th Pacioli workshop in 2008. The paper from 2008 described a pilot project which was initiated in autumn 2006 and finished in 2008. Based on a clear indication that the data flow is ineffective in the agricultural sector in Norway, we tried to identify all aspects of the current data flow. Here we detected how the data flow was carried out in practice and what amount of data we were talking about. Of course the project also gave a hint of how a more effective dataflow could be carried out. The report from the pilot project ended with a present value calculation and a recommendation for a concerted action.

Before we go to the next step in the project we will provide a brief summary of the goals from the pilot project. Then we will turn to some issues from the ongoing main project.

12.2 Main conclusions from the pilot project

The pilot project shows that there are great possibilities in, and a demand for more uniform data and a more targeted data flow between the authorities, organizations, cooperating business partners and the farmer. This applies to the farmers' partners in both the private and public sectors. Cost benefit analysis shows that the efficiency and targeting through the introduction of voucher data flow alone can give a net present value of over NOK 200 million. These calculations are made for a 10-year period for the agricultural sector totally, which here means the farmer's most important customers and suppliers as well as the accounting industry. Later calculations show NOK 430 million. The difference between these two calculations is among other factors that the last calculations use existing infrastructure and even more data flows are included. The data flow project will also give other important beneficial effects which are not estimated.

Agriculture is changing and everyone in the business sets higher standards for knowledge, information and good decision making at all levels. Coordination and targeting of important data flows will improve decision making for farmers and their partners. The benefit of better decisions would probably far exceed the aforementioned efficiency gains.

To make this documented efficiency gain, the agricultural industry should develop a common infrastructure and professional standards for efficient data flow and thus better decision support. With more standardized data and a better data infrastructure, Norwegian agriculture has an opportunity to increase the competitiveness through professional development, good organization and use of technology. In order to follow up these suggestions the pilot project proposed a main project with 3 parts:

1. Professional development with the clarification of requirements for data input and opportunities for improved decision basis for farmers and their partners;
2. Organizing of joint infrastructure solutions for data flow;
3. Technical testing of standardized, electronic document flow between the farmer customers and suppliers, and accounting offices.

The proposed main project requires broad support from the agriculture industry, involvement of agricultural authorities and considerable effort from central stakeholders. In addition to the participants in the pilot project new important participants must be invited to take part. It is suggested that participants should contribute both financially and with labour.

Figure 12.1 Present data flow of farm level data in the Norwegian agricultural sector

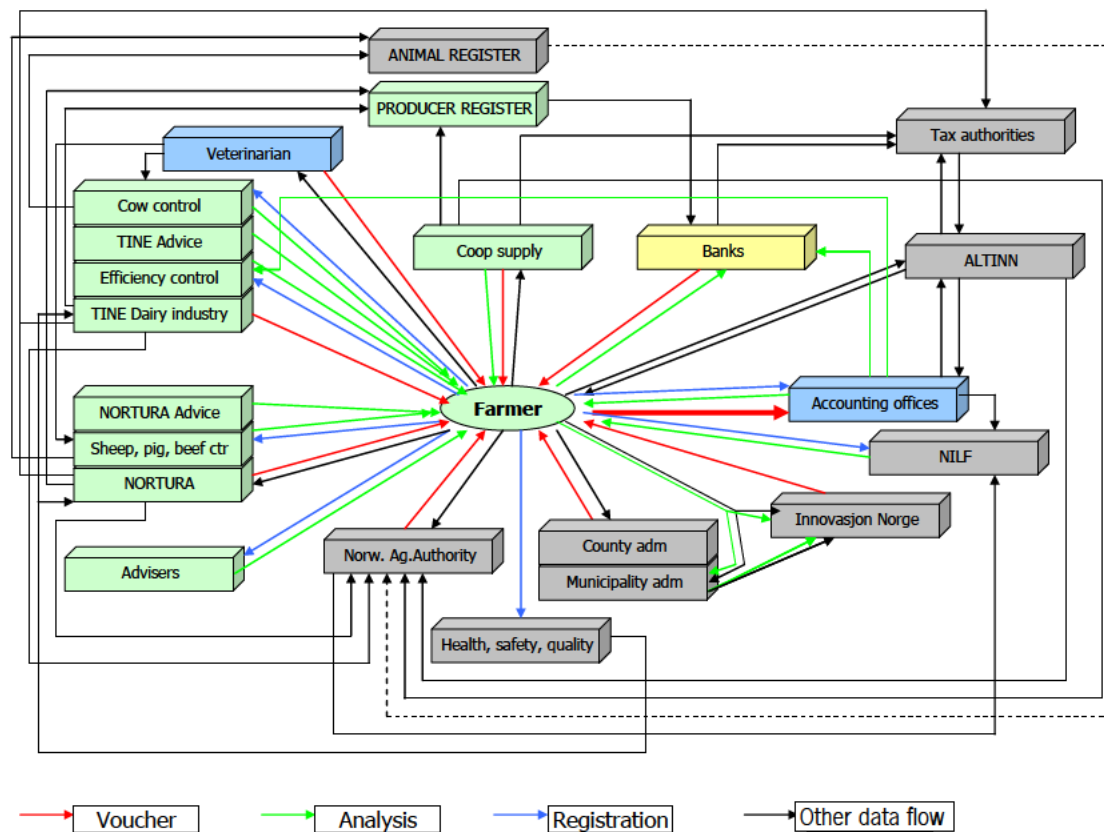

12.3 Main project

This main project focuses on developing common standards and infrastructure for the dataflow. Common standards and infrastructure will give easier access to relevant data for the farmer and other users of farm level data.

The participants in the main project are mostly the same as the participants in the pilot project. These are different processors and users of farm data like representatives from accounting offices, unions for accountants, farmers unions, dairy industry, slaughterhouses, purchase cooperatives, banks, insurance companies and software programmers. Like for the pilot, NILF is leading this main project. The participants have formed a joint partnership and are committed to carry out the project. The financing of the project is a combination of both direct financial support from the partnership and own efforts from within the partnership.

The project has pointed out several goals for an electronic data flow. Under are some of the ideas listed:

- Less data registration burdens for the farmer
 - One place to login for the farmer
 - Register data only once
- Better quality and more information flow into the accounts
- Better and cheaper decision support for the farmer

- Profitable outcome for the partnership (financial drivers)
- Get a joint infrastructure for the dataflow

Up to now everyone has built up their own system for data exchange, there has been very little interaction. In the future, data must flow electronically to all who rightfully seek the data. Here we stress that the farmer owns the data and he must have the opportunity to control the access to his data. The data must be split so no one receives more data than requested, and the data requested must be, if possible or necessary, in real time. All these wishes require better tools at all levels and it gives us the opportunity for better decision making.

If all these wishes that have emerged in the pilot project shall become a reality, it is a great need for standardization in many areas. It applies to how data is transported, content in the data streams, involved coding systems and processes. The main project seeks to address these problems in four steps:

- Standardization and pilot testing (2008-2011)
- Further standardization and adjustments, preparing the infrastructure (2011-2012)
- Requirement specifications and developing the infrastructure, programming and testing of the infrastructure (2011-2013)
- Operation stage (2013 -), implementation of standards and infrastructure, maintenance of standards and operation of infrastructure

12.3.1 Standards

The need for common standards has become more and more obvious in the progression of the project. To our experience, it takes time for actors to agree on common standards on data reporting. There are many parties involved, and everyone must agree to a set of new standards to reach the efficiency goal. So far, standards have been prepared for the following fields:

- Standard code system for accounting and decision making
 - Chart of accounts
 - Operation branches
 - Product codes
- Standard management accounting, including standard reports
- Standard operational information from the farmer
 - Information about the farm in general
 - Area use
 - Crops
 - Production method
 - Production technique/capacity
 - Labour input on the farm and outside the farm
- Standard for invoices and product payments
 - EHF. Invoice standard based on UBL. This standard is adopted for use in the public sector from 2012
 - e2b. Invoice standard that is adopted by many Norwegian companies

In the sequel we shall focus on the account system, invoice and product payment standards.

Standard code system for accounting and decision making

The chart of accounts in the Norwegian accounting system for agriculture has in many ways become too narrow, at least if one still wants to retain a hierarchical system. An electronic data stream calls for more space. In the table below we have briefly described a proposal for a complete code system. The system is not yet approved, but it shows the way we think in a new system with a complete specification of production method, products and product groups. The system enables different levels of specification. This will make the system flexible.

As one can see, several code sequences are repeated. The reason for this is that the codes can be used separately without the combination of each other and without the link to an account. The branch code for instance can be used in conjunction with labour specifications.

The product code in this system can not specify all kinds of products or groups of products, and shall not replace commodity codes from all branches. The codes should be a common minimum code that all recipients of such data can benefit from. Therefore we have focused on these products:

All sales products in agriculture:

- Concentrates
- Fertilizer
- Silage
- Pesticides
- Veterinarian services
- Direct subsidies
- Insurance

Table 12.1 A complete code system for accounting and decision making

Accounting string	Digit position	Describing text	Code example	Example
Division	1	Division: Agriculture, forestry etc.	2	Agriculture
	2		0	
Account	1	Sales incomes/costs	3	Sales incomes
	2	Different types of incomes/costs	0	
	3	Different types of incomes/costs	4	Slaughtering
	4	Different types of incomes/costs	0	
Product	1	Main product level 1	1	Agriculture conventional product
	2	Main product level 2	3	Animal products
	3	Product group	2	Meat products
	4	Product type	1	Cattle products
	5	Category/Sort	3	Bull
	6	Sort/Quality	1	E (EUROP-quality system)
	7	Quality/Race	0	Race (not specified)
Branch	1	Main branch	2	Agriculture branch
	2	Main production branch	1	Animal production
	3	Production branch	1	Cattle production
	4	Type of production	1	Milk production
	5	Production	2	Combined milk and meat production

Standards for product payment and invoice

The most important sources of information carriers are the vouchers (invoices and product payments). Information on deliveries to slaughterhouses, dairies etc. is of great interest, not only for accounting, but also for many other purposes. The standard list of coding as indicated above can be electronically linked to the commodity lists from the suppliers and buyers. This means that the detailed financial figures and the amount of numbers can be read electronically into the accounts. The project has been running a pilot for two years where one tests how standardized product payment, accounting and product codes flow into the accounts by means of XML-files. Here we use the e2b standard (mentioned above).

The figure below shows the actors who take interest of agricultural data from product payments and invoices. In order to satisfy so many users of shared data, it is absolutely necessary to standardize both the coding and the data flow.

At the moment we are trying to create an industry standard for invoices and product payments in agriculture. One year ago the Agency for Public Management and eGovernment (Difi) presented a new superior standard for invoices (EHF). Our agricultural standard should follow this standard.

Figure 12.2 Actors who take interest of agricultural data from product payments and invoices

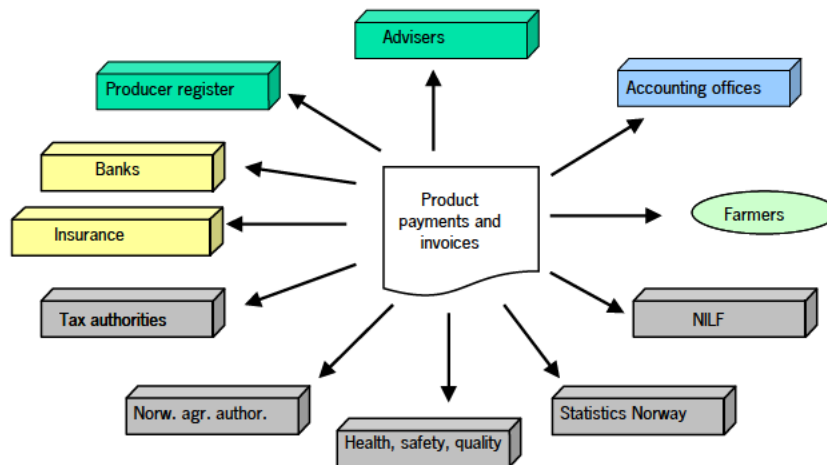

12.3.2 Infrastructure

When this project comes into an operational phase it is going to transport large amounts of data, depending on the support. This requires a safe transport channel with high capacity, and secure logon. In Norway the government has established a public portal called Altinn. This is a web portal where businesses and citizens can do their statutory reporting and share information with different public institutions. Once logged in to this portal one can submit data directly or fill in forms with sensitive information. Only public authorities and agencies can be service providers in Altinn. NILF will temporarily be the service provider for the entire data flow. Only data which is of interest for public authorities can be sent in this portal. For agriculture that means nearly 100% of the product payments and a small amount of the invoices.

All requirements of the data flow project will be met in the Altinn portal. Most of the data transport through the portal will be XML-files.

The figure below shows how the Altinn portal works as a hub and how the dataflow will be organized.

Figure 12.3 How the first operational version of the data flow is organized

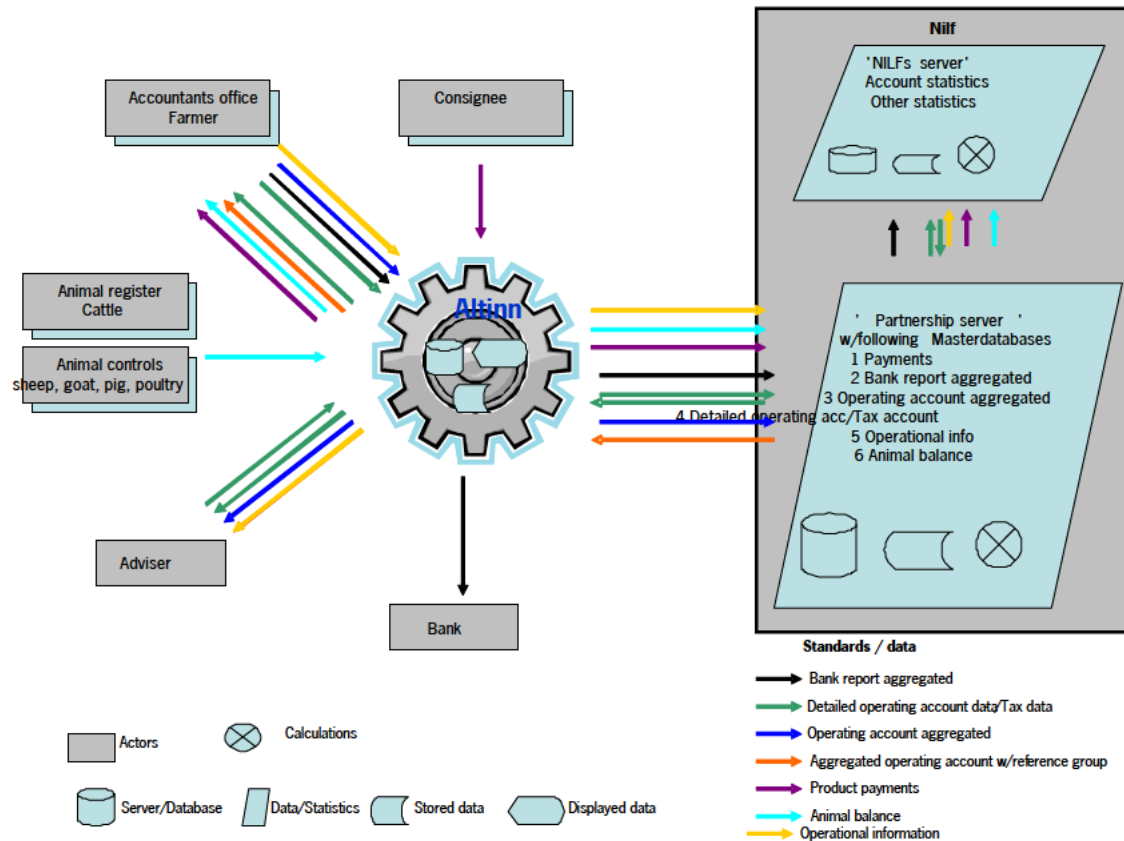

12.3.3 Consequences for Account statistics (Norwegian FADN)

The collecting of data is already influenced by the proceeding process in the partnership within the agricultural sector. The main data source today, the farmer's accounts, is being electronically transmitted from the accountancy office to NILF by a secure upload of a flat file on internet. Most of the economic data is included, but often information is lost on the way through the accountancy offices due to aggregations. Details needed for different purposes in the account statistics have to be supplemented from other sources. Tax accounts are specified according to taxation of the farmer. During the last years the tax account has been simplified. The needs for taxation do not coincide with the needs for research and statistics, and many farmers do not buy operational accounts which are more relevant for scientific purposes. Earlier NILF also asked the accountancy offices for the vouchers, and handled the transactions partly manually. This is an expensive way of generating statistics and the risk of human errors (tainting the dataset) is inevitable.

An agreement between the participants in the account statistics and NILF allows NILF to get additional data from other registers and merge the data with the account file. Several registers in the agricultural partnership supply NILF with adequate data today. This work has been done outside the main project. In this period awaiting the implementation of the Dataflow project, the working relationship in the agricultural sector has been crucial for us to allow access to extended data sources. In the Dataflow project, most partners feel an obligation to contribute and acknowledge the benefits of the project.

Today, NILF gets supplementary data from different registers like Cow and goat control (data from milk production), Norwegian Agricultural authority (grants, land use, etc.), Slaughterhouses (amounts and number of different animals), Dairy industry (quantities).

Implementation of the new system demands a lot of changes in NILF on all levels. Large amounts of data will pass in and out the institute's systems. The account statistics have to implement the new stand-

ards in all the operative systems. For inclusion of earlier years, the conversion of older volumes into the new standards must be done within the next two years.

12.4 Collection of data

The two main software contractors for accountancy offices in Norway cover about 90 % of the market, and are therefore important participants in the project partnership. Both software producers generate a flat export file to NILF today. Future files will be less aggregated and include more information. The coming systems will easier transmit data between the participants. An important goal for the project has been to lower costs by using available information within the partnership instead of collecting the same information from the farmer several times.

Today, much preliminary work on statistics in NILF goes into harmonising data from different software producers with their different standards and fluctuating dialects. Some accounts do not seem to follow any standard at all. Standard management accounts will use common standards for all the members of the partnership. Farmers with management accounts participating in NILF's account statistics will then be easy to handle.

12.5 Quality of the data

Electronically transmission of standardized data among all the organizations in the partnership reduces the risks of mistakes in processing data in the different systems. Better quality of the data creates more reliable results and statistics. The need for wide quality assurance will decrease, and this will hopefully lower costs in the handling and processing of data.

Easier data transmission also opens for presentation of more fresh statistics. Account data are often accused of being obsolete when presented, since they usually are released more than a year after the accounting year. Earlier presentation of account statistics is one of the features of the new system. Rapid changes in the market and the constraints for the agricultural sector call for fresh information. The new system will result in more data being directed towards NILF. It will be a significant supplement to our existing data material. This will also allow an increased number of participants at a lower cost in NILF's annual account statistics. This concerns especially data from farms and productions which are poorly represented in the statistics.

For researchers and account statistics, a larger amount of data available outside the survey, will be useful for more thorough analysis of farms and farm outputs.

12.6 Use of data

When all the partners in the sector have implemented the same new standards, it will be easier to relate performance measures to the financial results. Misinterpreting data based on different content in the financial results is the source of many public discussions and political debates. Farm income results may fluctuate a lot among different institutions. New standards with an exact content and a common understanding will probably reduce the danger of delusions and bring along a more temperate discussion.

More detailed data on quantities of products together with the quantities and composition of fertilizer and pesticide may also provide new areas of application for the accountancy data. The demand on farm level data for environmental and climate research is increasing, and this new system of information increases the value of the data. It will probably also open for new approaches to the account statistics in new areas not known today.

The implementation of the new standards requires a lot of work within the internal systems in NILF. This opportunity may however open for an essential renewed approach to the publication of the statistics.

An interactive web platform for the users and a presentation of the results with export options, are features that has been on the agenda for some years but when priorities are made they fall behind. This type of process and new services may be accelerated when the Dataflow project is implemented.

12.7 Bottlenecks

There are still a lot of discussions in the partnership about levels of registrations and the design of the different standards. The recurring discussions are the fear that the system incurs future costs and different needs among the partners. For most partners more aggregated data seems sufficient, and NILF is accused of being too focused on the level of details, especially related to inputs. For NILF however, it is not satisfactory to invest heavily in the project without the benefit of adequate data for research. The partners working on advisory service share these desires.

Another uncertainty is the future degree of support of the new systems in the partnership. It is still a risk for breakdown in different parts of the project. The accountancy business in Norway is fragmented in small companies with only a few employees. Their capacity to implement the systems and utilize the new possibilities is decisive for NILF to benefit on the project. There is a risk for NILF to maintain former systems in addition to the new ones for a long time.

The farmers own their data, and administrate access through a web interface. NILF will probably only be granted access to parts of the farmer's data in the systems. Not all farmers want to be investigated by researchers or participate in statistics. Participation in the account statistics in Norway is voluntary (with some exceptions coming from Statistics Norway).

Implementation of the new systems will be a great technical challenge for the institute. Imports and exports of large data sets demand better infrastructure and more technical knowledge. Outsourcing of services might be a solution for parts of the implementation and management in the future. The main project will affect a lot of people and comes at a price. A high economical effort and occupying staff might influence other projects in NILF negatively.

Although only a portion of the total dataflow in the project is useful to our institute, NILFs position as project leader all in all creates great opportunities. On the minus side, about 10 % of the farm accounts are not covered by the members of the partnership. This means that NILF either have to maintain the present systems which will be expensive or exclude the rest of the farmers from the population.

12.8 Conclusions

The pilot project shows that there are great possibilities and a need to streamline and target the main data flow between the organizations, cooperating partners and the farmer. Cost benefit analysis shows that the agricultural sector can give a net present value between NOK 200 and 430 million and may be even more.

The follow up project has focus on developing common standards and infrastructure for the dataflow. Common standards and infrastructure will give easier access to relevant data for the farmer and other users of farm level data.

The main goals for the project are:

- Less data registration burden for the farmer
 - One place to login for the farmer
 - Register data only once
- Better quality and more information flow into the accounts
- Better and cheaper decision support for the farmer
- Profitable outcome for the partnership (financial drivers)
- Get a joint infrastructure for the dataflow

- Developing new standards is an important part of the main project. It will be developed
- Standard code system for accounting and decision making
 - Standard management accounting, including standard reports
 - Standard operational information from the farmer
 - Standard for invoice and product payment

Implementation of the new standards and systems demands a lot of changes in NILF on all levels. The account statistics have to implement the new standards in all the operative systems. For inclusion of earlier years, the conversion of older volumes into the new standards must be done within the next two years. Implementation of the new standards and systems will:

- Simplify data collection
- Improve the quality of the data through more information, more detailed information and fresher data
- Extend the use of the data to new purposes like environmental- and climate research
- Lower costs in generating statistics
- Bring along great technical challenges for the institute and occupying staff and resources in the institute the coming years. It might influence other projects in NILF negatively.

12.9 References

Kjesbu, E., K. Staven, K. Andersen, S. Lutnæs Enget, F. Mork Håskjold and H. Moskvil, *Data flow and basis for decision making in Norwegian agriculture*. NILF report no 2008-13. 2008.

Erland, K., E. Øvren and H. Torbjørn, *Exchange of data for decision making in Norwegian agriculture*. Paper presented at the 16th Pacioli workshop. Norwegian Agricultural Economics Research Institute, Oslo, 2008.

NILF *Account statistics in agriculture and farm forestry 2009*. Norwegian Agricultural Economics Research Institute, Oslo, 2010.

Kjesbu, E., Ernst & Young, The Brønnøysund Register Centre, *Altinn-løsning for dataflyt i landbruket*. Report from the Data flow project, Trondheim, 2010.

13 Storage of farm data online (via internet)

Sami Chaudhary



Online Storage of FADN-Data

Sami Chaudhary

MTT Economic
Research, Finland.



DATABASE

- Relational Database
Sybase SQL
 - Sybase based tools; Sybase Central, PowerBuilder, InfoMaker
 - Farm level data, not aggregated (all recorded data at the basic level; labour input, products, inputs, fixed assets, receipts etc.)
 - Data from different fields of business activities on the farm; agriculture, horticulture, forestry, reindeer husbandry, fur animal husbandry, OGAs
-

FARM DATA

Farm level data

Data and accounts from different fields of activities on the farm
= whole farm business

General data:

- general information of the farm
- cash incomes and expenditures from the tax-bookkeeping/return

Additional data: Annual query on forms

- labour input - persons, types of work, machinery work
- use of agricultural land - crops, areas, yields
- production - production, purchases, sales, use
- stocks and animals - products, animal groups
- change in assets and liabilities - changes in balance sheet items: investments, sales, receivables, payables.

FARM DATA

Annual data

Cash incomes and expenditures

- Manual books
 - cash-book 1 and 2, a book for working hours
- Bookkeeping programs; journal, general ledger, reports
- Additional data: query on forms
 - manually filled or use of pdf-format

First year

- Foundation of farm in the registers
- Creation the data of fixed assets
 - dedicated forms, manual/pdf-format, manual recording by MTT

Online data storage

- Data storage application, *Martti*, is developed with PowerBuilder, an integrated development environment owned by Sybase.
- Martti is a desktop application, deployed to web-application to access it via internet with a web browser.
- The web-application is hosted on a dedicated windows based web-server and is connected with the local database by default.
- The application is password protected. After successful login, the accounting officers can access to the farms assigned to their research centers.

Martti – program

Executable/web application
User interface to database

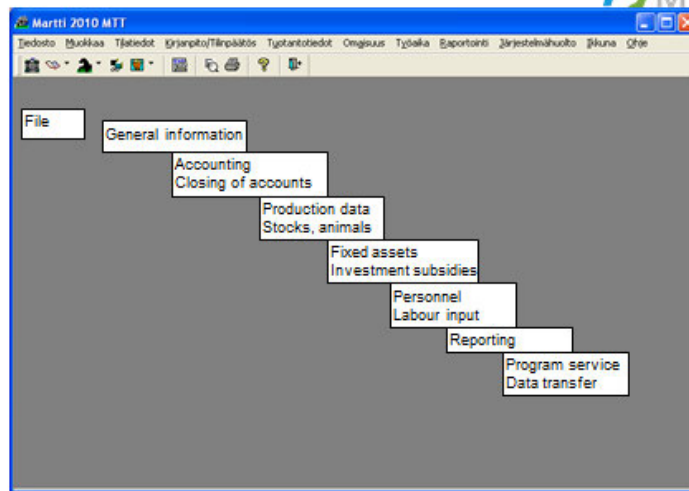
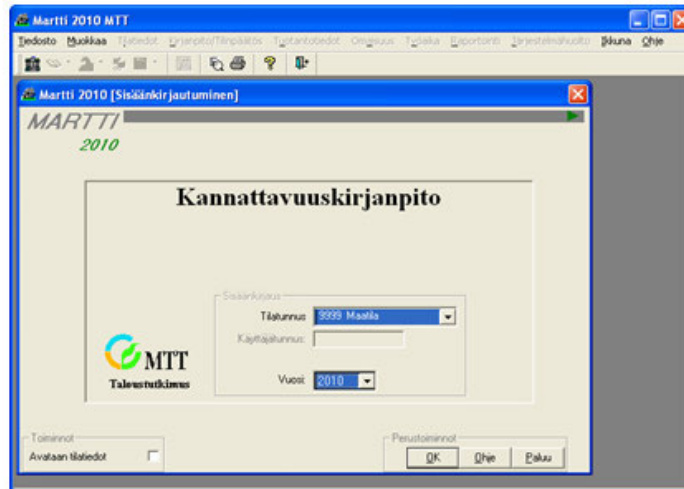

Martti_näytöt

Online data storage



- Application has integrated feature to validate the filled data.
- The validation is done by connecting to the checking server via FTP, where several tests are done with a separate checking application.
- The report of test results is generated and sent back via web browser.
- The data is then submitted after corrections (if necessary), which is stored initially in the database located on web-server.

Checking application

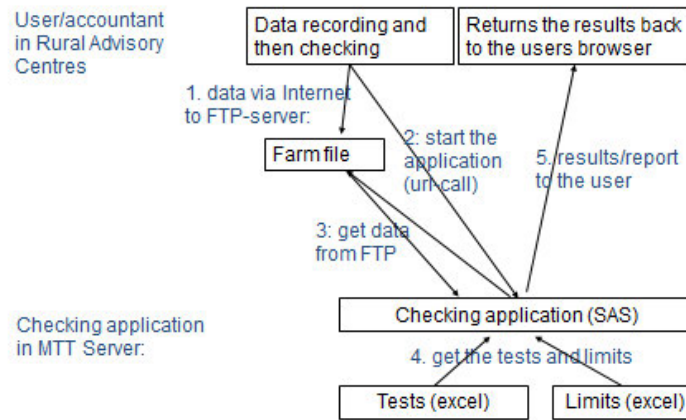

Data Storing Application

- The farm data is stored initially in the database located in web-server.
- The researchers can then connect to the web-server database and and check the data online.
- Alternatively, data can be downloaded to the local computer using the same application.
- After correction of the data (if necessary), it is finally stored in the production database.
- The FADN data is prepared from the production database by converting to the correct format to be sent to RICA1.

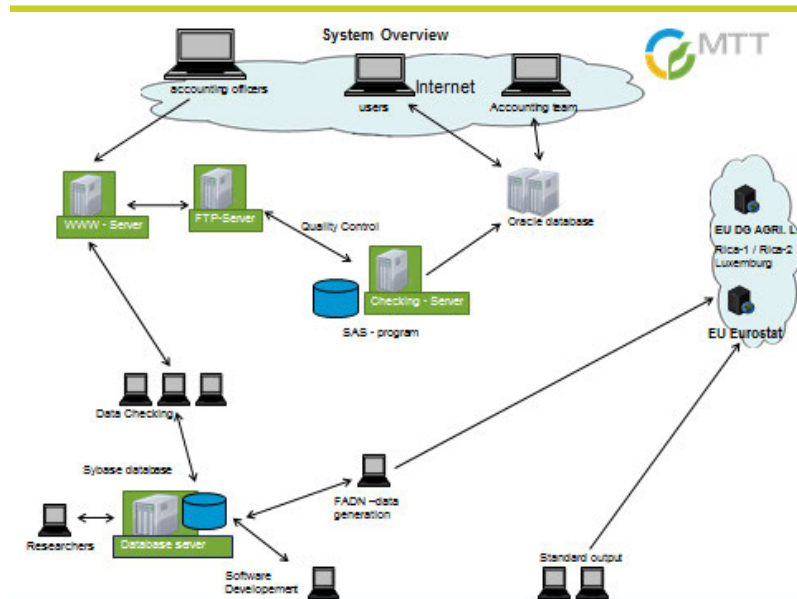

14 Application of FADN and other information systems in the management of the advisory service in agriculture

Zoran Bardakoski, Vesna Ilievska, Lars Olsson

14.1 Introduction

This paper attempts to illustrate how the present organisational development work at NEA (a government agency providing advisory service in agriculture in F.Y.R. Of Macedonia) will affect the role of FADN within NEA and particularly change the conditions for obtaining good quality in the data collected. The core reason for this is the well established fact that the more interested a data provider is in the use of the data provided the more motivated and able he or she will be to provide data of good quality.

14.2 Organizational set-up

NEA was founded in 1998 through transformation of former advisory centres for development of the agriculture, which functioned since 1972. The transformation was supported by the World Bank Project with an aim to achieve better quality of advisory services for the individual farmers. The Agency is an independent institution and it is financed directly from the budget of Republic of Macedonia. The relations to different stakeholders is illustrated by Figure 14.1 below (MAWFE is the Ministry for Agriculture, Forestry and Water Economy).

Figure 14.1 Stakeholders

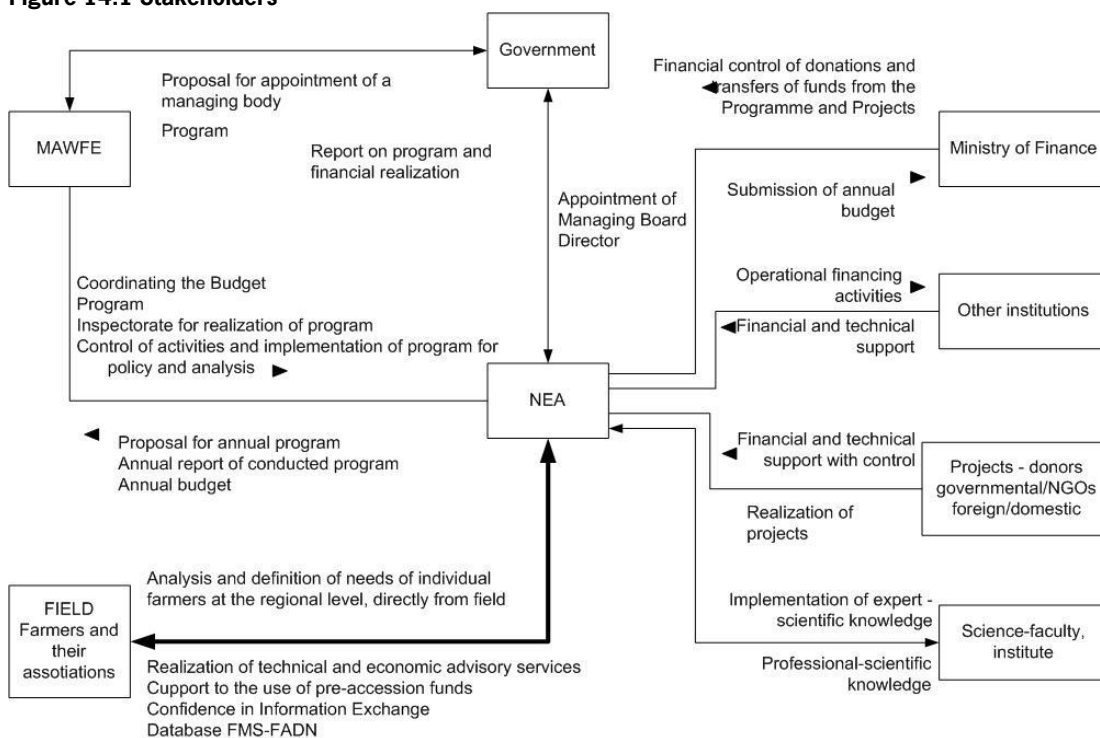

NEA headquarters is settled in Bitola, the biggest agricultural region in Macedonia. NEA has 30 working units all over Macedonia grouped in 6 regional centers. NEA is divided into 3 sectors. The main sector is the Sector for development of the agriculture. The organisational structure of NEA is given by Figure 14.2 below.

Figure 14.2 Organisation structure

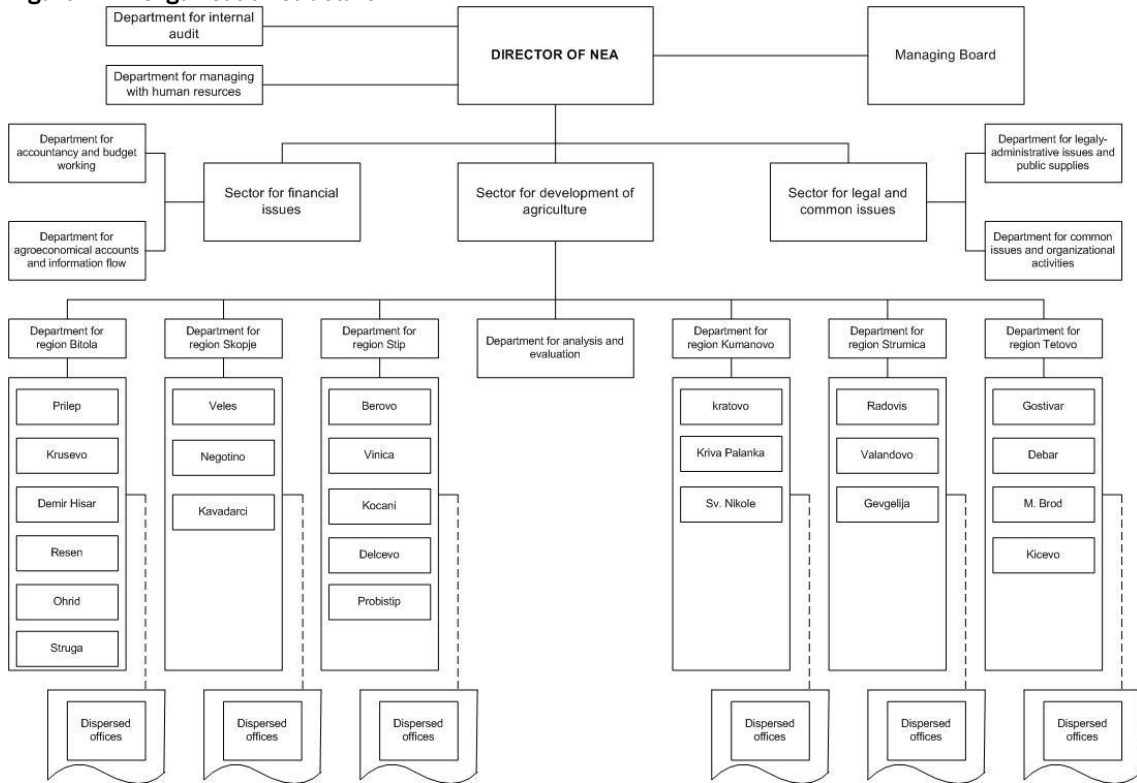

The main - but not only - task of NEA is advisory service. The different tasks are illustrated in Figure 14.3 on the next page.

Figure 14.3 Program activities

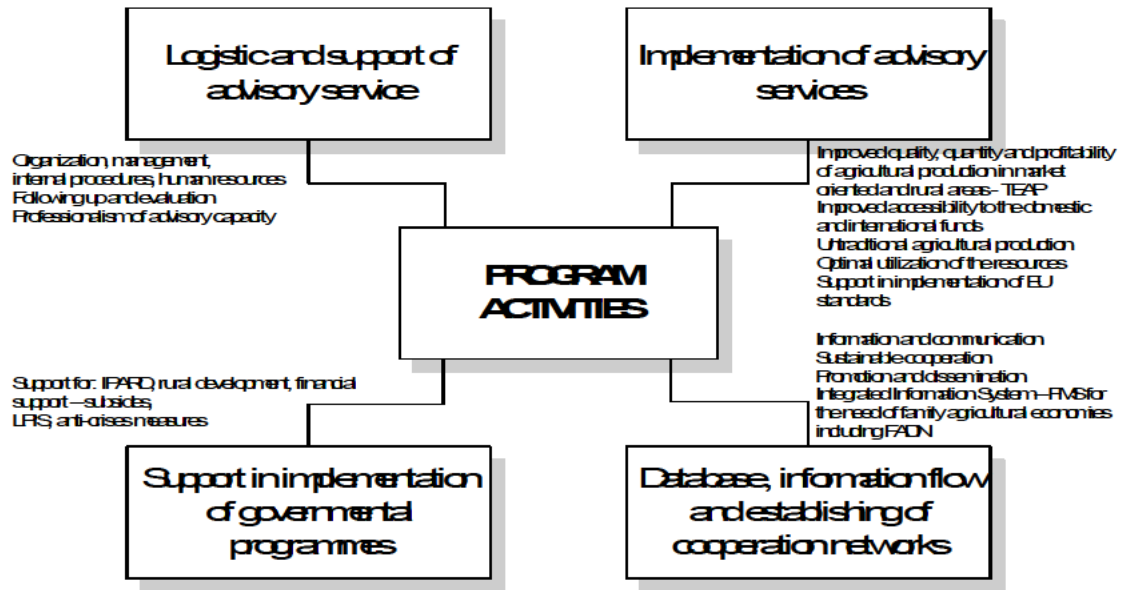

14.3 The advisory service

The essence of the advisory service will always be the interaction between the advisor (or group of advisors) and the beneficiaries of the advisory service - individual farmers, cooperatives or associations. In every such interaction the effort should be to utilize the resources of NEA in such a way that knowledge of the best possible methodology for the specific situation is transferred to the beneficiary. Figure 14.4 below illustrates the working processes and the information flow to reach that optimal state.

Figure 14.4 Working processes

MAP OF WORKING PROCESSES AND INFORMATION FLOW

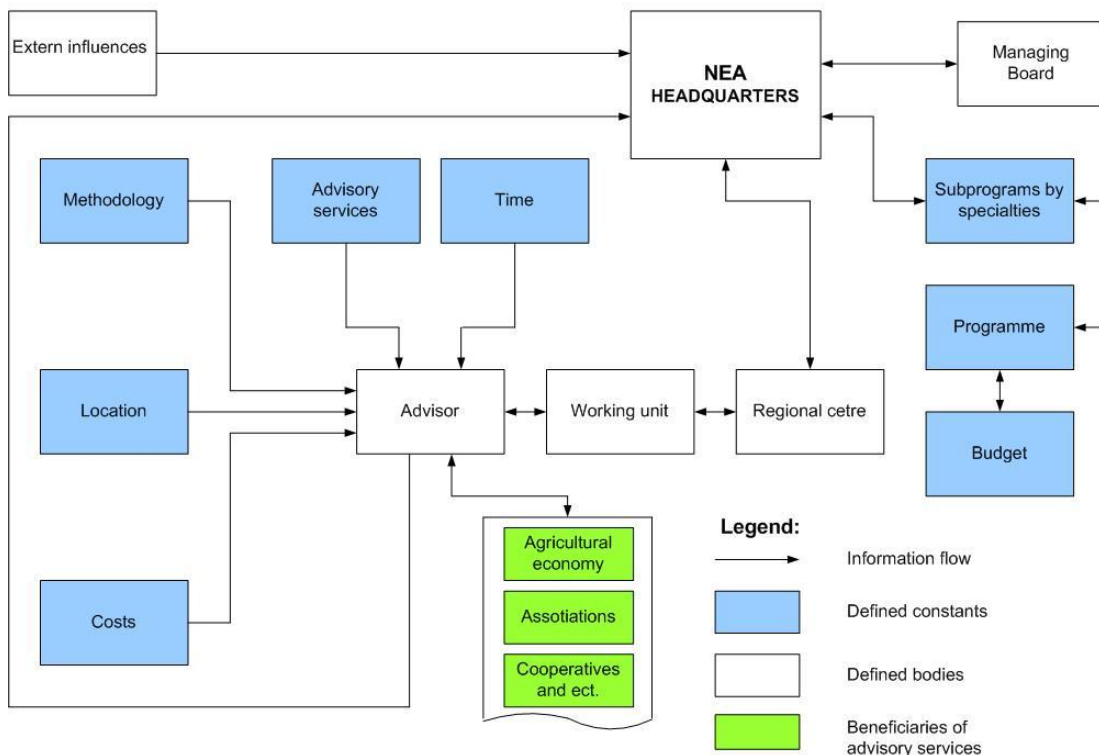

14.4 Organizational development

Recent organisational development has centred around two important areas, one to form a better basis for professional development and support through creating coordinative groups, the other being better systems and routines for monitoring and evaluation of both the organization and the staff. Improved use of internal (and also external) data is a central element in both the two areas.

14.5 Coordinative groups

The creation of coordinative groups means that groups are formed for different areas of specialisation among advisors (such as crop production, livestock etc.). They consist of a national coordinator, usually but not always from the head office, one regional coordinator per region (6) and individual advisors. They provide a forum for exchange of ideas and experience and they can also be a channel for contacts with other institutions involved in agricultural work and research. Individual advisors can get support from the group when problems occur. One can see the coordinative groups as a complement to the regionally structured organization, and directed at the development and strengthening of specialized skills.

One such coordinative groups is for Agro-economy. Among its responsibilities is the collection of data for FADN (and FMS which for NEA forms the basis for FADN). One important task for this group has been to promote the use of collected data to assist the farmer in analysis of the economic characteristics of his/her specific farm. Another is the use of collected data to analyse NEA's performance.

Figure 14.5 describes the structure of the coordinative groups.

Figure 14.5 coordination groups

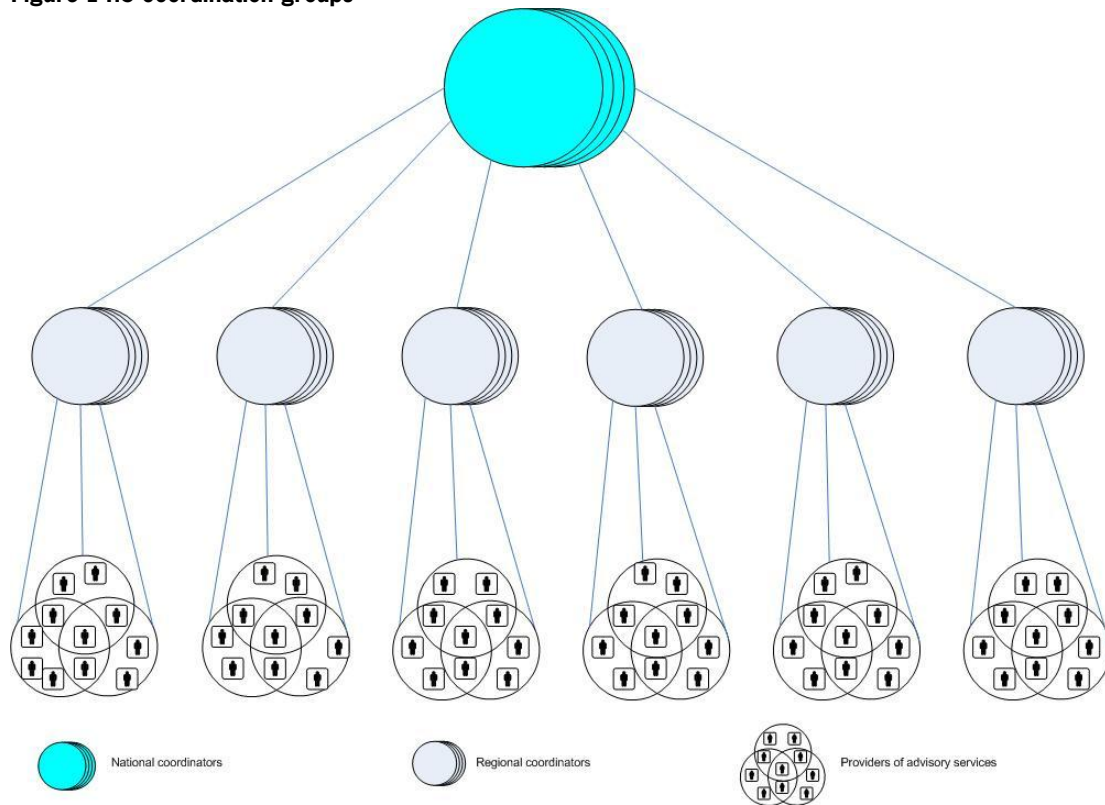

14.6 Improved planning, monitoring and evaluation

The improvement of monitoring and evaluation has several aims:

- To give a more clear view of planned, ongoing and finished activities in the advisory service
- To get a better base for monitoring the advisors as well as staff in managerial positions
- To include indicators of output, outcome and impact of the activities in order to be able to better manage the organization and also continuously improve the advisory service

To support the monitoring and evaluation system an IT-system (SEMPA) is under development. The evaluation system is illustrated in Figure 14.6.

Figure 14.6 System of evaluation

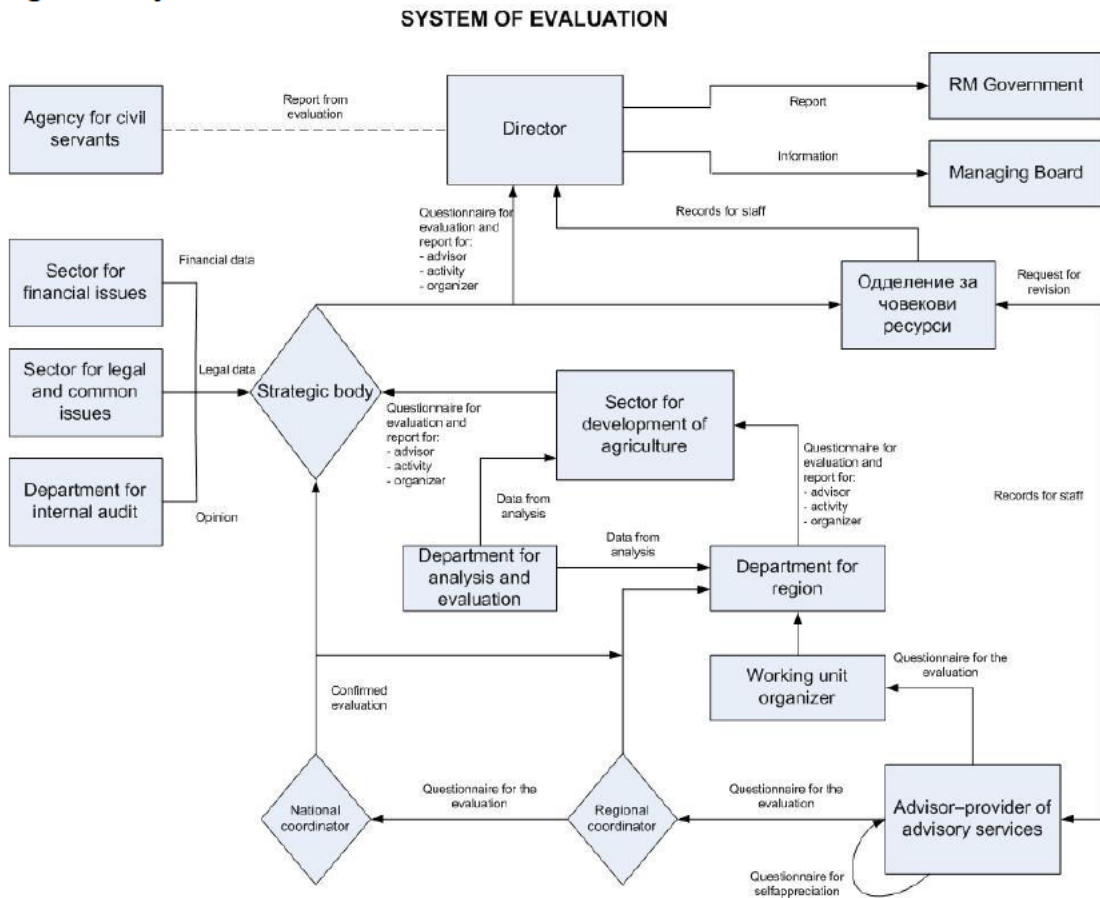

Figure 14.7 illustrates in more detail how staff in different roles participate in the evaluation:

Figure 14.7 Implementation of organizational chart

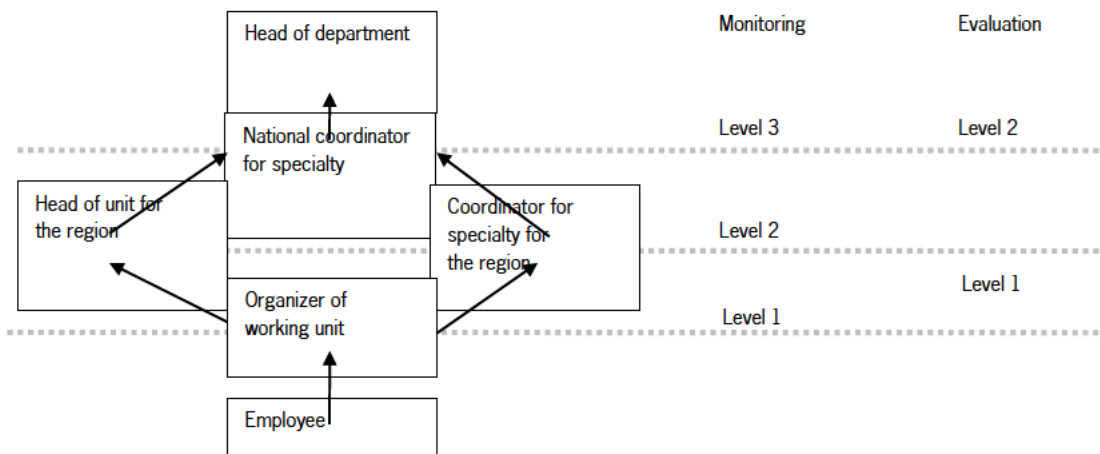
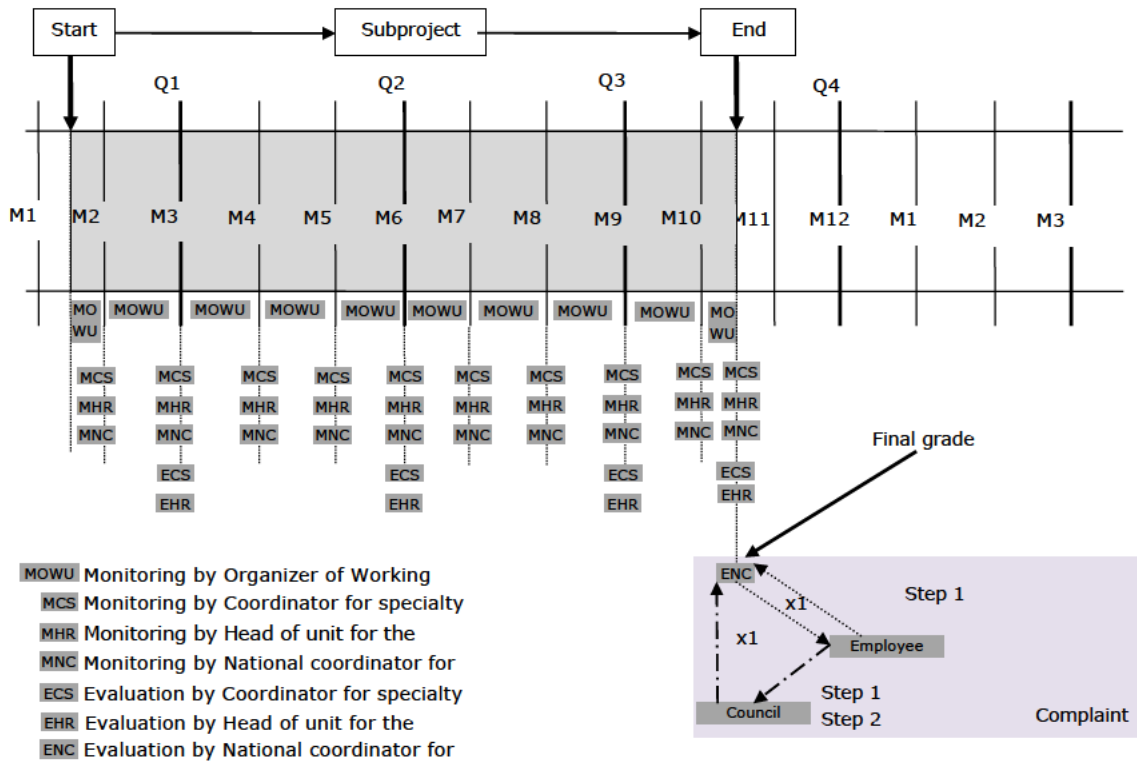

Figure 14.8 Process of monitoring and evaluation



- In the organisational development the idea is to strengthen the links in the interaction between:
- The quality of data collected for FADN (and other systems)
 - The quality in the interaction between the farmer and the data collector (in NEA the advisor)
 - The benefit of good quality for the farmer
 - The benefit of good quality data for the advisor
 - The use of data on farm level for analysis
 - The skills of the advisor doing the collection
 - The organisational development of NEA to focus and improve the advisory service - the ability to give advice suited to the specific needs for different categories of farms

Figure 14.9 illustrates the interactions.

Figure 14.9 The interaction between organizational development, data use and data quality

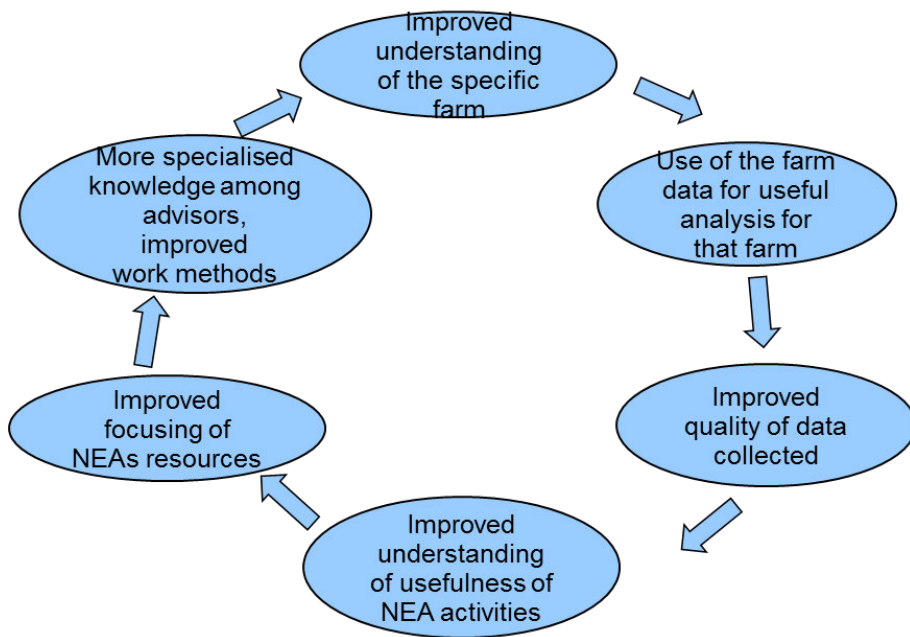

This organizational development is now well under way, and hopefully the full force of these mutually supporting improvements will gradually transform both NEA as an organization, but more importantly the agricultural sector it supports.

15 Use of FADN data for appraising sustainability of Italian farms, strengths and weaknesses of the current database

D. Longhitano, A. Bodini, A. Povellato, A. Scardera

Within the current FADN database sustainability indicators (environmental, social and economic) have been identified. In some cases estimations have been necessary and in some other cases thanks to allocation of costs (crop protection and fertilizers), to the registration of physical information (quantities of fertilizers) and to other details assembled with the Italian methodology (irrigation system, socio-demographic information) indicators have been directly derived. Starting from a multi-criteria matrix a Sustainability Farm Index (SuFI) has been calculated at farm level. The index includes the three dimensions of sustainability. The methodology has been applied to the regional FADN sample of Veneto of 2009. The current FADN database has demonstrated to be a valuable source of information to monitor the environmental and social farm assets, beside the economic one. However, additional informative modules seem necessary to integrate the current set of information in order to describe comprehensively the environmental and social aspects of agricultural holdings in the context of the assessment of sustainable development.

15.1 Introduction

Over the last twenty years, sustainable development has become a worldwide priority objective as defined in the 'Declaration of Rio' at the conclusion of the 1992 United Nations Conference on the Environment and Development. Pursuing this objective implies preserving the productive potential of the economy, made by the stock of natural, human and man-made capital. The three forms of capital represent the three dimensions of sustainability: environment, society and economy, where the latter two dimensions have always prevailed in the public debates and in the policy implementation.

Agriculture sustainability is a recurring issue and has gained relevance in the last decades, alongside the need to rationalize the use of production inputs and reduce the agricultural environmental impact. Sustainability means 'meeting the needs of the present without compromising the ability of future generations to meet their own needs' (WCED, 1987). Since 1990's, the integration of environmental objective into sectorial policies has become one of the main strategic objectives of the European Union (EU). Due to the close interdependence between agricultural activity and natural capital, the environmental dimension of sustainability is one of the crucial issues in the Common Agricultural Policy (CAP) reform and it arises many conflicts with the economic and social objectives that have substantially characterized the past and current public intervention in the agricultural sector.

To reach the new objective in a rational and transparent way, it was decided to set up an information system able to monitor the evolution of farming systems under an environmental perspective. Indicators represent one of the most appropriate tools to tackle this task. As stated by the European Commission, 'indicators provide the basis for assessing progress towards the long-term objective of sustainable development' (CEC, 2000). Indicators are effective and ready-to-use support tools to decision-makers. There are many examples of complex system of environmental indicators developed by the European Commission for monitoring and assessing the farming systems in general (e.g. see IRENA project in EEA, 2005) and the policy implementation process (e.g. the Common Monitoring and Evaluation Framework for monitoring and evaluation of Rural Development Programmes 2007-2013).

Sustainability is a multifaceted concept that includes environmental, economic and social objectives and on this base, policy makers must be able to take decisions according to the criteria of sustainability.

In particular analysts and policy makers need to be able to rank decisional units according to sustainability criteria. For this to have a single index that aggregates different dimensions of sustainability is necessary and useful.

This study aims to analyse farm sustainability by exploiting as much as possible the current FADN database as main source of information and to calculate a comprehensive sustainability index. Since it is widely recognised that farm is the basic unit for sustainability assessment the index has been calculated at farm level. The index represents an aggregation of data from a set of environmental, economic and social indicators. Similarly to other studies, the purpose of this methodology is to monitor the sustainability of farms, checking at the same time the strength and weakness of the current information availability of the FADN database.

15.2 A short literature review on the assessment of sustainability

At macro level there are some experiences in defining a reference scale for assessing sustainability. For example, in Giardin et al. (2000) the AGRO*ECO method has been developed. It is a tool for the evaluation of potential impacts of farm practices on single agricultural and environmental components: the tool uses multi-criteria methods to generate agro-ecological indicators (AEI). Trisorio (2004) assessed the development of Italian agriculture towards sustainability suggesting a set of agri-environmental indicators taking into account social, economic and environmental dimensions of sustainability. The author proposed a possible solution to the problem of aggregation with a synthetic representation of the sustainability in agriculture. Katona et al. (2005) examined farm inputs on the basis of OECD and Eurostat data, structuring the DPSIR model, according to agri-environmental indicators of IRENA project.

Even at the micro level, several researches have been implemented. One of the first example to be mentioned is the environmental accounting method at farm level developed by Pacini et al. (2000). In this case environmental externalities generated by farming cycles were measured, based on site-specific environmental indicators.

Considering studies that used FADN database and worked at farm level, we can mention Andersen and colleagues (2007) which developed farm management indicators, using information on the intensity of farming at EU level member States (EU-15). They considered bi-dimensional farming typology based on land use and intensity in order to evaluate the environmental performance of farms. Another contribute comes from Van Passel et al. (2007), that implemented an empirical model to measure farm sustainability using FADN dataset from a group of dairy farms in Flanders during the period 1995-2001. The authors defined a 'sustainable value' and 'sustainable efficiency' of the dairy sector at farm level.

Sydorovych and Wossink (2008) proposed a conjoint analysis to identify economic, social, and ecological issue promoting an aggregate sustainability assessment, based on relative impact on the overall sustainability measure. The authors demonstrate how conjoint analysis could be used as a standardized tool for sustainability assessment and comparison of stakeholder perceptions of what is important for sustainability.

Recently, many efforts have been made to define a scale of reference to assess sustainability. In response to the need for monitoring and assessing sustainability at farm level, a common methodology for assessing the environmental impact of European agri-environment schemes (AES) was developed, the so called Agri-Environmental Footprint Index (AFI). AFI is a farm-level, customizable index that aggregates measurements of agri-environmental indicators. This index has several advantages as it is based on common framework for the design and evaluation of policy that can be customized to locally relevant agri-environmental issues and circumstances. The AFI structure is flexible, and can respond to diverse local needs. Its processing is interactive, and entails the engagement of farmers and other relevant stakeholders in a transparent decision-making process that can ensure acceptance of the outcome (Purvis et al., 2009). The AFI algorithm implies a step-wise process that incorporates multi-criteria analysis (MCA) (Mortimer et al., 2008). Ideally, AFI values are calculated for each farm in a representative sample of a category.

ry of farms; thus, the approach enables tracking of temporal changes and/or comparisons between groups of farms that participate in an AES and those that do not.

There are several studies that apply the AFI approach. The most recent one comes from Westbury et al. (2011) which apply the AFI methodology in combination with data collected in the Farm Business Survey (the FADN survey in England). They tested whether the AFI methodology could be extended for the routine surveillance of environmental performance of farming systems using established data sources. They indeed demonstrated that the methodology can be potentially widely applied to similar data sources across the EU-27.

Finally, another interesting approach is presented by Reig-Martinez et al. (2011) that implemented an assessment of sustainability at farm level building up composite indicators for social, economic, environmental issues. The approach followed combines Data Envelopment Analysis (DEA) and Multi-Criteria Decision Making (MCDM) methods.

15.3 Methodology

The Sustainable Farm Index (SuFI) has been developed as a variant of AFI approach methodology (Mortimer et al., 2008) in order to propose a comprehensive index including not only the environmental dimension, but also the economic and social ones. The calculation of the index is a step-wise process, adapted here for monitoring sustainability of farms.

Firstly, the context of the analysis was established, that includes all farm types (FT) of the regional FADN (Veneto regional) in a single snap-shot (accounting year 2009). The FTs are aggregated according to the most relevant ones for the region, therefore eight groups were built: 1) intensive arable crops, 2) others arable crops (included permanent grassland), 3) grapevine, 4) permanent crops, 5) mixed crops, 6) cattle farms (with bovines), 7) other livestock and 8) mixed farming.

The second step includes the specification of an assessment criteria matrix (ACM). The ACM is based on the three dimensions of sustainability (environmental, economic and social) and two relevant management domains, namely Farm Management (FM) and Regional Contest (RC). The former links the farm management to sustainability, whereas the latter links sustainability to the territorial contest (Table 15.1).

Table 15.1 Assessment Criteria Matrix used for the calculation of SuFI of FADN Veneto sample

	1. Environmental dimension	2. Economic dimension	3. Social dimension
4. Farm management (FM)	Nitrogen content Phosphorus content Irrigation area Irrigation system Pesticide expenditure	Return to labour Return to land Utilized Agricultural Area Expenditure for service Expenditure for energy	Family labour Farmer age Farmer gender Farmer education
Region Context (RC)	Land constrain Livestock Unit Organic farming Grassland Agri-Environmental Schemes	Altitude Other Gainful Activities Town distance	Altitude Town distance Social capital Labour supply

The core issue of this phase has dealt with the involvement of stakeholders (agronomists, ecologist, agricultural economists), which shared their viewpoints during a recent regional conference on agriculture and rural development (INEA, 2011). In fact, with reference to sustainability, they stressed on topics such as water management, preservation of natural resources, landscape and human capital.

Once the main structure of ACM was agreed, indicators were identified for each criterion. This step consists in filling each cell of the matrix with indicators from the current Italian FADN database. Altogether

the ACM used in this study is made of 26 measurable indicators, some of which are monetary-valued, while others social and environmental.

In some cases indicators were derived by estimation and approximations. For instance, in case of missing values in the data set, the amounts of fertilizers were derived from expenditure on fertilizer and dividing it by a standard cost to estimate the quantity used. The registration of fertilizer quantities and prices helped to estimate all other cases where the information is missing. Furthermore, the registration of the type of fertilizers addressed the researchers to prices, enhancing reliability of information.

- *Environmental dimension* - Besides irrigated area, the irrigation systems were distinguished according to low and high water consumption, respectively sprinkler and surface-flooding system. To tackle to environmental dimension in terms of integration within the RC, the following indicators were taken into account:
 - Land constraint meant as area belonging to Natura2000, or SIC/ZPS, was derived from the municipality code.
 - The participation to agri-environmental schemes (AES) was considered as binary (participating or not), as well as the organic agronomic practices (organically farmed or not).
- *Economic dimension* - Agricultural holdings were grouped taking into account the variability of NVA/AWU, NVA/ha, income from Other Gainful Activities (OGA), expenditure on energy and contract work and farm dimensions in terms of cultivated area (UAA).
- *Social dimension* - Farmer age was grouped in four groups: under 35 years old, between 34-45, between 45 and 60, over 60 years old. Farmer education was based on levels of qualification: none, school only; secondary only; University degree.

To tackle to social dimension in terms of social integration within the RC, the following indicators were taken into account:

- The distance of the holding from the inhabited centre was grouped into 4 categories (under 5 km, between 5 and 10, between 10 and 15, above 15 km).
- Labour supply, meant as the difference between total labour involved at the farm level and the family labour, so the potential and real need for labour besides family/internal demand.
- The altitude area was grouped in mountain, hill and plain.
- The degree of networking was measured by the subscriptions to associations, which in the Italian methodology can vary between one and four. Farms were grouped accordingly.

The social dimension took into consideration the human (labour, skills and knowledge) capital and equal opportunities, the natural capital (land, water) was considered within the environmental dimension. However, the current FADN database has not allowed going into further details at this stage. Further exploitation of information assembled is feasible and forthcoming.

After the identification of indicators, the *normalization* of indicator scales allowed to sum up different indicators. Indicator values were converted into scores according to the relationships between indicators values and level of sustainability. Relationships can be linear, non linear, and scaling can be categorical or binary (see Mortimer et al., 2008). For each indicator scores are on a 0-to-10 scale. The weight assignment followed, namely a weight was assigned to each cell of the matrix. The two management domains, FM and RC, were considered equally important in achieving the three sustainability dimensions. Therefore a weight of 0,5 was assigned respectively.

Within the three dimensions, each indicator was associated with different weights according to how much stakeholders have evaluated the importance of each indicator to sustainability dimensions. According to AFI methodology (Mortimer et al., 2008), in creating such an indicator matrix, the same indicator

may validly be used in more than one dimension¹. Overall, a weight was assigned according to relative importance of each criterion.

Table 15.2 Values of the indicator in Veneto FADN sample

Indicator	Number	Data type	Units	Min	max	Mean	Stand. deviation
Agrienvironmental scheme	853	class	binary	0	1	-	-
Altitude	853	class	coded	1	3	2	1
Contract work	853	variable	euro/hectare	0	28.580	170	1.077
Energy expenditure	853	variable	euro/hectare	0	132.113	1.493	7.636
Family labour	853	variable	hours / hectare	0	16.720	531	1.298
Farmer age	853	class	coded	1	4	3	1
Farmer education	853	class	coded	1	4	2	1
Farmer gender	853	variable	binary	0	1	-	-
Grassland area	178	variable	%	1	100	49	0
Irrigation area	852	variable	%	0	100	50	0,43
Irrigation system high insensitivity	852	variable	%	0	100	8	0,25
Irrigation system low insensitivity	852	variable	%	0	100	42	0,42
Labour unit	853	variable	labour unit/hectare	0	15	0	1
Labour supply	853	variable	hours / hectare	0	27.203	141	1.172
Land constrains	853	class	binary	0	1	-	-
Livestock unit (LU)	853	variable	LU/hectares	0	326	3	20
Networking degree	853	class	coded	0	5	3	1
Nitrogen balance	806	variable	quintal/hectare	0	1.275	3	45
Organic farm	853	class	binary	1	2	-	-
Other gainful activities	853	class	euro	1	5	-	-
Pesticide expenditure	807	variable	euro/hectare	0	20.383	368	1.061
Phosphorous balance	806	variable	quintal/hectare	0	1.275	3	45
Return to labour	853	variable	euro/labour unit	-29.625	561.534	38.664	50.140
Return to land	853	variable	euro/hectare	-5.059	435.115	8.962	29.724
Town distance	853	class	kilometres	0	4	1	0
UAA class	853	class	hectares	1	6	2	1

Source: our elaboration on Veneto FADN dataset (2009).

The fifth step consisted in the SuFI calculation by summing up scores by weights at each level within the hierarchical SuFI structure. The general index can score between 0 and 10.

The last step consisted in the sensitivity analysis to allow comparisons of farms by considering different scenarios. In this study four scenarios were defined. The first one, called 'indifferent scenario', assigns equal importance to the three dimensions of sustainability and to the two management domains. The other three scenarios - leaving unchanged the two domains (FM and RC) - differ from one another because of the relative importance placed on the three dimensions accordingly (e.g. 80% to the most important one while the other two dimensions share the remaining 20%). Therefore SuFI has been calculated under the environmental, economic, and social scenario.

¹ For example, considering the distance of the farm from inhabited centres is a useful indicator to describe both social and economic dimension of regional networking. In fact proximity to town centres may help social contact, but also enhance contact to the economic marketplace. However, such indicator has been assigned a different weights (relative importance) within the two dimensions. Similarly altitude was used in the two dimensions with different importance to sustainability.

15.4 First findings

The above-described method was applied to the regional FADN database of Veneto, an Italian north-eastern region, accounting for 853 agricultural holdings in 2009.

The mean SuFI score shows low variability under the indifferent scenario, as it varies from 5,8 and 4,8, although the index itself could vary between 0 and 10. Nevertheless, differences in the mean values are statistically significant ($F_{7,845} = 47,6$ $P < 0,01$), as well as in the other scenarios (Table 15.3).

The mean score of SuFI is lower under the environmental scenario than under the indifferent one, whereas is higher under the economic one. This result can be linked to what is represented in Table 15.4 which suggest that by stressing on the environmental dimension of sustainability, in spite of the economic dimension, farms perform poorly. Furthermore given the variables used, stressing on the social dimension does not lead to easily-explicable differences (mean Sufi 5,5) even though statistically significant.

According to farm types, farms with bovine livestock show higher sustainability (mean value of 5,8 under the indifferent scenario), due to the high presence of grassland areas, which are typically extensive. Viticulture and Other crops, among which horticulture is included, are less sustainable than others, due to the very intensive use of chemical inputs. This reappears also under the environmental scenario, where Intensive arable crops. Other crops, Viticulture and Permanent crops show low sustainability. Those farms were expected to be low performing under the environmental scenario and conversely highly performing under the economic scenario.

Table 15.3 Mean scores of SuFI according to Farm Type and scenarios

	Indifferent scenario	Environmental scenario	Economic scenario	Social scenario
Intensive arable crops	4,8	3,6	5,6	5,2
Other crops	5,0	3,9	5,9	5,3
Viticulture	4,9	4,1	5,1	5,6
Permanent crops	5,1	3,5	5,8	5,9
Mixed crops	4,8	3,7	5,4	5,4
Bovine	5,8	5,8	5,9	5,6
Other livestock	5,4	4,7	5,8	5,7
Mixed farms	5,4	4,9	5,8	5,5
Total	5,2	4,3	5,7	5,5
F (7,845)	47,6	85,0	10,4	11,3
p-value	<1%	<1%	<1%	<1%

Examining the constituent components of the index (under the indifferent scenario) shows that farms on mountain areas scored highly in environmental dimension as a whole (both FM and RC), whereas for dimensions relating to the interaction between socio-economic issues and regional contest farms on the plain are scored highly (Figure 15.1).

Figure 15.1 Mean scores of components of SuFI under indifferent scenario, according to altitude

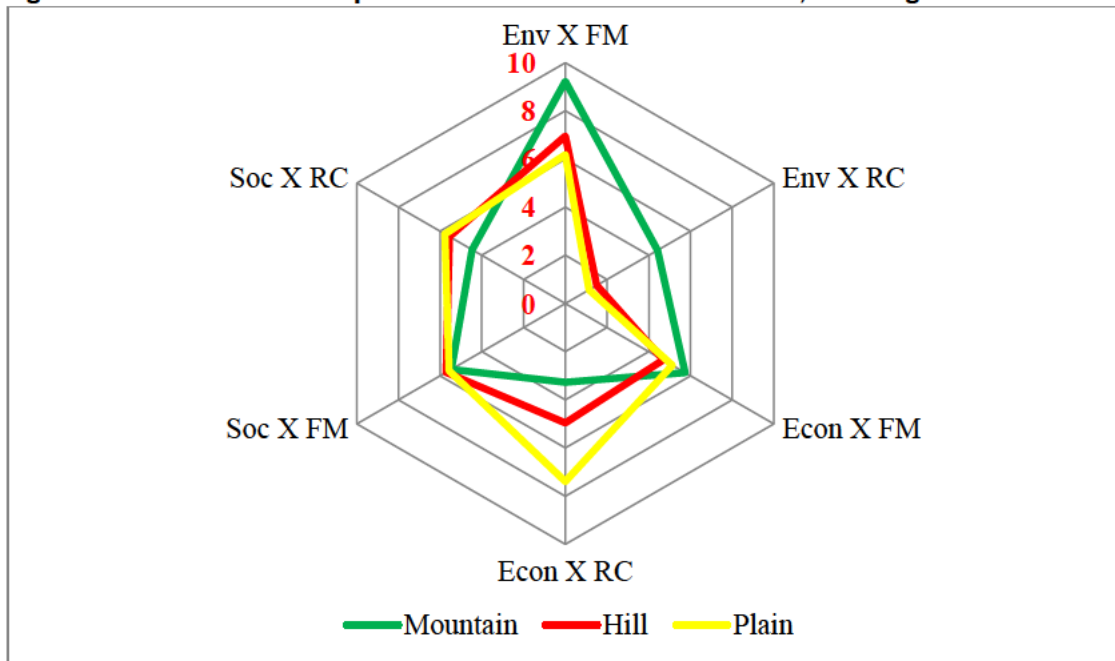

Source: our elaboration on Veneto FADN dataset (2009).

The components of the index (under the indifferent scenario) show that large farms (above 100 ESU) scored highly in almost all dimensions and domains, especially relating to the interaction between economic dimension and farm management (Figure 15.2). The only exception is represented by small farms (below 8 ESU) that scored highly in environmental dimension relating to Farm Management. Analysing the interaction of economic dimension and RC, interesting results can be observed, due to the fact that farms that are extreme in size (both very small and very large ones) score highly.

Figure 15.2 Mean scores of components of SuFI under indifferent scenario, according ESU

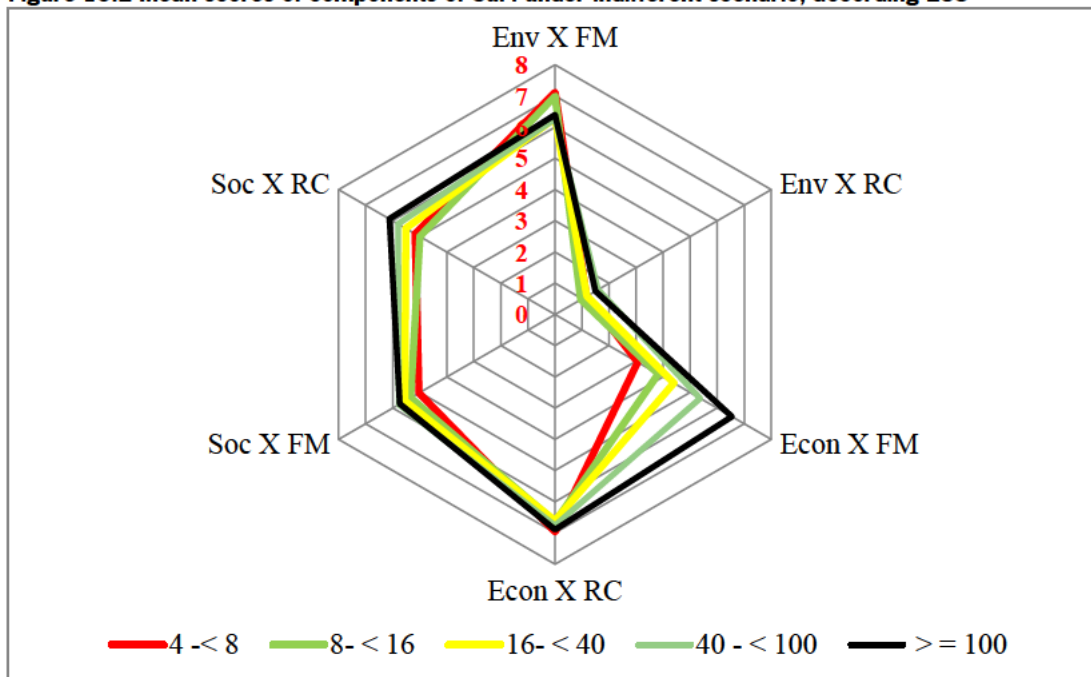

Source: our elaboration on Veneto FADN dataset, 2009.

Three levels of sustainability were identified, that are Low with SuFI score < 5; Medium 5-6; High with SuFI > 6. The distribution in terms of number of holdings, UAA and NVA were analysed. Attention can be drawn to 12% of farms that are highly sustainable, accounting for only 20% of the regional UAA and 35% of regional NVA.

In terms of NVA low sustainable farms under the economic scenario, accounting for 68% of the regional NVA, correspond to 77% of NVA under the economic scenario.

15.5 Final remarks

The FADN database has proved to be a valuable source of information in providing data necessary for the quantification of a sustainable index and for monitoring farms with it, confirming a former analysis made by Mari (2005). It should be kept in mind that FADN cannot represent the sole source of information for such a use, since it was established for other purposes.

Nevertheless, thanks to data assembling of quantities of inputs, the estimation of Nitrogen and Phosphorus consumption, at farm and crop process levels, was possible. Next to this registration, which is missing in some cases as not mandatory, data collectors are allowed to register the commercial name of fertilizers, in this way crossing this information with the crop to which the costs was allocated, fairly precise estimations could be done. Unlike other studies, next to irrigated UAA, the irrigation system was taken into consideration and distinguished among the amount of water consumed.

Table 15.4 Distribution of farms, Utilized Agricultural Area and Net Value Added according to classes of SuFI

Classes of SuFI	Peer scenario	Environmental scenario	Economic scenario	Social scenario
	<i>Number of farms</i>			
Low	44%	77%	22%	28%
Medium	44%	12%	40%	45%
High	12%	11%	38%	27%
Total	100%	100%	100%	100%
	<i>UAA</i>			
Low	24%	72%	9%	29%
Medium	56%	14%	23%	40%
High	20%	14%	68%	32%
Total	100%	100%	100%	100%
	<i>NVA</i>			
Low	15%	68%	4%	12%
Medium	48%	18%	19%	38%
High	36%	14%	77%	50%
Total	100%	100%	100%	100%

Besides these strengths, some weak issues shall be mentioned, particularly because some variables have been chosen as *proxy* due to lack of information as such. In terms of assumptions made, age (your farmers) and family labour (high FAWU) were considered as positive to social sustainability. Some could argue that employing family labour does not necessarily affect the social dimension of sustainability. However there was no other chance to integrate at this stage the current method of data collection nor to integrate the dataset with an *ad hoc* sample.

In absence of data and with data limitation, approximation is needed, some areas for improvements were identified and will be of next implementation in the Italian FADN. For instance, geo-referencing FADN data-

base will allow overcoming limitations of *proxy*, such as the estimation of the distance of holding from inhabited centres and territory characterization.

The social dimension could be included in the matrix thanks to information assembled on farmers and in the next examinations other details can be exploited, such as the number of members in farmer's family and degree of involvement in running the farm (hours worked per family member). From the economic point of view information on farmer household income can be used a proxy for farms wealth.

To conclude it seems remarkable that some informative modules are to be necessary in the future annual surveys, in order to describe comprehensively environmental and social aspects of agricultural holdings. All the coming efforts with this respect are more and more envisaged in farm evaluation with respect to sustainable development at national and international level.

15.6 Acknowledgments

The authors would like to thank Simonetta De Leo and Antonio Giampaolo for priceless support in data extraction from database and Agostina Zanolli for valuable support in statistical method.

15.7 References

Andersen, E., B. Elbersen, F. Godeschalk and D. Verhoog, 'Farm management indicators and farm typologies as a basis for assessments in a changing policy environment.' In: *Journal of Environmental management* 82 (2007).

CEC, *Indicators for the integration of environmental concerns into the common agricultural policy* (COM (2000) 20 Final). Communication from the Commission to the Council and the European Parliament, Brussels, 2000.

EEA, *Agriculture and environment in the EU-15: The IRENA indicator report*. EEA Report No 6/2005. European Environment Agency, Copenhagen, 2005.

Giardin, P., C. Bockstaller and H. van der Werf, 'Assessment of potential impact of agricultural practices on the environment: the AGRO*ECO method.' In: *Environmental Impact Assessment Review* 20 (2000).

INEA, Veneto Agricoltura, *Relazioni finali, Conferenza regionale dell'agricoltura e dello sviluppo rurale*. Legnaro, Italy, 2011. <www.venetorurale2013.org>

Katona, J.K., P. Takàs en G. Szabò, *Farm inputs and agri-environment measures as indicators of agri-environment quality in Hungary*. Conference paper presented at the Xith Congress of the EAAE, Copenhagen, Denmark, August 22 - 27, 2005.

Mari, F., 'Valutazione delle politiche agroambientali.' In: *Estimo e territorio* 7/8 (2005).

Mondelaers, K., G. van Huylenbroeck and L. Lauwers, 'Sustainable value analysis: sustainability in a new light.' In: *Eurochoices* 10 (2011), pp. 9-14.

Mortimer, S., A. Mauchline, J. Park, J. Finn, D. Edwards and J. Morris, 'Evaluation of agri-environment and forestry schemes with multiple objectives.' In: *Eurochoices* 9 (2010) 1, pp. 48-53.

Mortimer, S.R., J.R. Park, A.L. Mauchline, K.A. Haysom, D.B. Westbury, G. Purvis, G., Louwagie, G. Northey, J.A. Finn, K. Knickel, N. Kasperczyk, J. Primdahl, H. Vejre, J. Vesterager, L. Kristensen, K. Teilman, L. Podmaniczky, K. Balázs, G. Vlahos, S. Christopoulos, L. Kröger, J. Aakkula, A. Yli-Viikari and J. Peltola, *The Agri-Environmental Footprint Index: User's Manual*. 2008. Available from: <www.footprint.rdg.ac.uk/afimanual>

Pacini, C., A. Wossink, C. Vazzana and L. Omodei-Zorini, *Environmental accounting in agriculture: a theoretical with special reference to Tuscany*. Conference paper presented at the Annual Meeting of the American Agricultural Economics Association, Tampa, Florida (USA), July 30 - August 2, 2000.

Purvis, G., G. Louwagie, G. Northey, S. Mortimer, J. Park, A. Mauchline, J. Finn, J. Primdahl, H. Vejre, J.P. Vesterager, K. Knickel, N. Kasperczyk, K. Balazs, G. Vlahos, S. Christopoulos and J. Peltola, 'Conceptual development of a harmonized method for tracking change and evaluating policy in the agri-environment: the Agri-Environmental Footprint Index.' In: *Environmental Science & Policy* 12 (2009).

Reig-Martínez, E., J.A. Gómez-Limón and A.J. Picazo-Tadeo, 'Ranking farms with a composite indicator of sustainability.' In: *Agricultural Economics* 42 (2011) 5.

Sydorovych, O. and A. Wossink, *An Application of Conjoint Analysis in Agricultural Sustainability Assessment*. Conference paper prepared for presentation at the 12th EAAE Congress 'People, Food and Environments: Global Trends and European Strategies', Gent (Belgium), 26-29 August, 2008.

Trisorio, A., *Measuring sustainability, indicators of Italian agriculture*. INEA, Rome, 2004.

Van Passel, S., F. Nevens, E. Mathijs and G. van Huylenbroeck, 'Measuring farm sustainability and explaining differences in sustainable efficiency.' In: *Ecological Economics* 62 (2007).

WCED, *Our Common Future*. Oxford University Press, Great Britain, 1987.

Westbury, D.B., J.R. Park, A.L. Mauchline, R.T. Crane and S.R., Mortimer, Assessing the environmental performance of UK arable and livestock holdings using data from the Farm Accountancy Data Network (FADN). In: *Journal of Environmental Management* 92 (2011).

16 Working group 2: FADN indicators and info graphics

16.1 Results

Results of FADN are often published as tables and text. Images are however much stronger in attracting attention of readers and are more easily memorized. The adage 'A picture is worth a thousand words' refers to the idea that a complex idea can be conveyed with just a single image

Newspapers and especially internet make more and more use of images, so called info graphics in static or dynamic versions. Info graphics are graphic visual representations of information, data or knowledge. These graphics present complex information quickly and clearly.

FADN contains a wealth of detailed information. The value of these data could be increased by making use of modern presentation techniques.

Discuss the potential of info graphics for conveying key messages from FADN. Have you experimented with images and info graphics to communicate key messages? Which indicators have been used? Give examples if possible.

Please report on:

- Is there a future for info graphics for FADN?
- Interesting indicators
- Practical applications or ideas for visualising FADN results

16.2 FADN indicators and info graphics

FADN results are often published as tables and text. Images are however much stronger in attracting readers attention. The adage 'A picture is worth a thousand words' refers to the idea that a complex idea can be conveyed with just a single image. Newspapers and internet make more use of images 'so called info graphics in static or dynamic versions.

FADN contains a wealth of detailed information. The value of this information could be increased by making use of modern presentation techniques. Participants were asked to discuss in smaller groups the potential of info graphics for conveying key messages, what are their experiences with info graphics, which indicators have been used and to provide examples.

16.2.1 Is there a future for info graphics for FADN?

There were a general consensus that there is a future for info graphics for conveying key FADN messages, indicators, and time series.

Here is a list of potential advantages of info graphics:

- Could increase visibility and understanding of FADN data.
- Info graphics are more attractive and easy to understand as they convey less information and require less knowledge from readers to interpret and grasp key messages compared to traditional statistical graphs.
- The future of info graphics will depend of the content to be displayed.
- Might be more suitable for familiar indicators (e.g. share subsidies in total farm income) and in-depth information (costs, yields, benchmarks ...).
- Interactivity is also appealing (e.g. user selects a variable and sees the impact and changes over time).
- Could potentially cut through translation issues and save time.

However, there were some concerns expressed such as:

- Need to develop knowledge and skills to adapt new technology. This may take away or require some trade-off between resources for more FADN data analysis and resources for info graphics.
- Software may be expensive and limited in terms of availability
- Maps should have the proper resolution (more regional maps)
- Figures and data points behind the info graphics should remain available
- Need to know the audience, who will be the target groups (tax-payers, decision-makers...)
- Good tool to promote FADN data to wider stakeholders however, the innovation need to be controlled (good to be innovative but with care to prevent misuse or wrong interpretation)
- Indicators must be quite simple and understanding of info graphics consistent
- Trade off between accuracy and visibility/impact

16.2.2 Interesting indicators suitable for info graphics

Here is a list of potential indicators identified by different groups:

- Main productivity indicators comparing to others (e.g group average, other countries, EU average etc.)
- Productivity labour
- Share of subsidies in total income
- Structure of production costs
- Financial indicators: assets, liabilities, equity...
- Market information: commodity prices...
- N efficiency
- Farmland birds
- Piles of manure
- Porsche = high NVA per AWU

16.3 Practical applications or ideas for visualising FADN results

Some participants expressed the need for the Commission to ask member states interest about info graphics and play more coordinating role to share best practice. More EU level analysis should include info graphics.

Here is a list of potential application or ideas identified by different groups:

- Publishing of the data
- Further analysis of FADN results
- Publications of research highlights
- Cooperation with newspapers - info graphics, other publications - advertising of FADN
- Comparison among countries: my country - EU, UK, Baltic countries
- Times series and maps
- Apps for iPhone
- Simple graphs (like pie chart, pillars ...)

17 First practical experiences with random sampling

Andreas Roesch

 Schweizerische Eidgenossenschaft
Confédération suisse
Confederazione Svizzera
Confederaziun svizra

Eidgenössisches Volkswirtschaftsdepartement EVD
Forschungskontakt Agroscope Reckenholz-Tänikon ART

First practical experiences with random sampling

Andreas Roesch
Tallinn, Oct. 5, 2011

Agroscope



Main reasons for the new Swiss sampling design

- non-random sampling
- poor representation of some farm types and regions
- AgroTwin is the only bookkeeping program allowing data delivery to the Swiss FADN

Agroscope

Andreas Roesch | | Research Station Agroscope Reckenholz-Tänikon ART
Practical Workshop Tallinn, Oct. 2-4, 2011

2



Major principles of new FADN design

- **Random** sampling (Rotating Panel)
- **Two samples** (A and B) for meeting different requirements
- **Reduction** of number of strata
(from 11 (farmtypes) X 3 (regions) X 5 (land classes) = 165
to 11 (farmtypes) X 3 (regions) X 2 (land classes) = 66)
- **Compatibility** with all accountancy software packages used in the agricultural sector in Switzerland

Andrew Horwich | H Research Station Agroscope Nendelnholz-Fankon ARI
Panel Workshop Tallin, Oct 2-4, 2011

2



Method

- ✓ **Non-prop. stratified random sampling**
(„optimum allocation“, Cochran, 1977)
- ✓ **Power allocation** with $p=0.75$ (Bankier, 1988)
- ✓ **Accuracy constraints** at both strata and country level
- ✓ **Collapsing of strata** if precision is not met or sampling fraction >30%

Andrew Horwich | H Research Station Agroscope Nendelnholz-Fankon ARI
Panel Workshop Tallin, Oct 2-4, 2011

4



Sample A and B

	Sample A	Sample B
Level of detail	low	very high
Farm types comprised	all strata	Plain region: 11, 21, 51, 53, 54 Hilly region: 21, 53, 54 Mountain region: 21, 22, 23, 31
Number of farms in the sample (2007)	2'002	2'299
Number of farms in the target population (2007)	43'964	33'417
Accuracy constraint for SGM at the Swiss level	CV<0.02	not defined
Accuracy constraint for SGM at the stratum level	CV<0.2	CV<0.15

CV=coefficient of variation

Farm types: 11: Arable crops; 12: Special crops; 21: dairy; 22: Suckling cows;
23: Other cattle; 31: Horses/ sheep/goats; 41: Pigs/poultry; 51: Comb. dairy/forage;
52: Combined sucklings cows; 53: Combined pigs/poultry; 54: Combined others

Andrew Horwich | H Research Station Agroscope Nendelnholz-Fankon ARI
Panel Workshop Tallin, Oct 2-4, 2011

5



Sampling fraction (sample A)

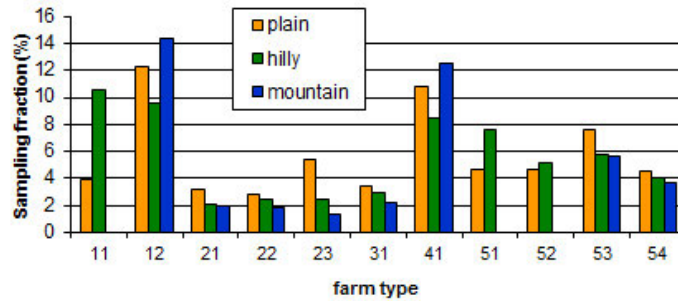

Andreas Hovewich | H Research Station Agroscope Nendelnholz-Ferikon ARI
 Pascal Workshop Tallinn, Oct 2-4, 2011

6

Agroscope



Results from first test phase sample A

Andreas Hovewich | H Research Station Agroscope Nendelnholz-Ferikon ARI
 Pascal Workshop Tallinn, Oct 2-4, 2011

7

Agroscope



Setup of test phase sample A

Year: 2010

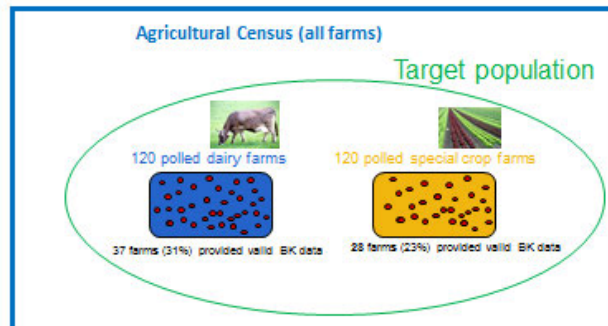

Holdings are polled by the Swiss Interview Institute LINK

Andreas Hovewich | H Research Station Agroscope Nendelnholz-Ferikon ARI
 Pascal Workshop Tallinn, Oct 2-4, 2011

8

Agroscope



Data Collection process

- ✓ **Questionnaire:**
 - paper or web-based
 - filled out by either farm manager (71%) or fiduciary (29%)
- ✓ **anonymous** (only LINK knows the addresses)
- ✓ (almost) no quality control (will be improved in 2nd test phase)

Andrew Howarth | H Research Station Agroscope Nendelnholz-Fankon AMI
Pascal Workshop Tallin, Oct 2-4, 2011

5



Response rates

	Total		Dairying		Special Crops	
	Number of holdings	%	Number of holdings	%	Number of holdings	%
Total	240	100	120	100	120	100
Wrong address/unknown	34	14	17	14	17	14
Valid address	206	86	103	86	103	86
Open (contact problems)	14	6	5	4	9	7
Refusals or no financial accounting	48	20	31	26	17	14
Ready to participate after telephonic contact	144	60	66	55	78	65
Ready to participate after mentoring interview	119	50	60	50	59	49
Questionnaire returned	76	32	39	32	37	31
Questionnaire completely filled out	65	27	37	31	28	23

Andrew Howarth | H Research Station Agroscope Nendelnholz-Fankon AMI
Pascal Workshop Tallin, Oct 2-4, 2011

10



Response (Dairying & Special Crops)

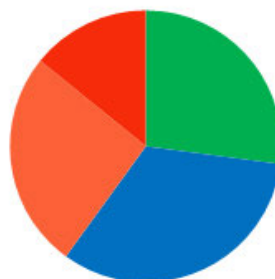

- Questionnaire completely filled out
- Ready to participate but form not / not completely submitted
- Refusals/open
- Unknown/ wrong address

Andrew Howarth | H Research Station Agroscope Nendelnholz-Fankon AMI
Pascal Workshop Tallin, Oct 2-4, 2011

11



Geographical distribution of the languages of CH



Andrew Howarth | VV Research Station Agroscope Hohenholz-Ferikon ARI
Petal Workshop Tallin, Oct 2-4, 2011

12



Response rates (type & language)

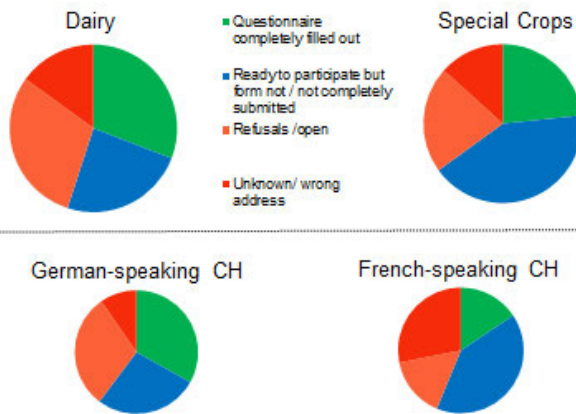

Andrew Howarth | VV Research Station Agroscope Hohenholz-Ferikon ARI
Petal Workshop Tallin, Oct 2-4, 2011

13



Special crops

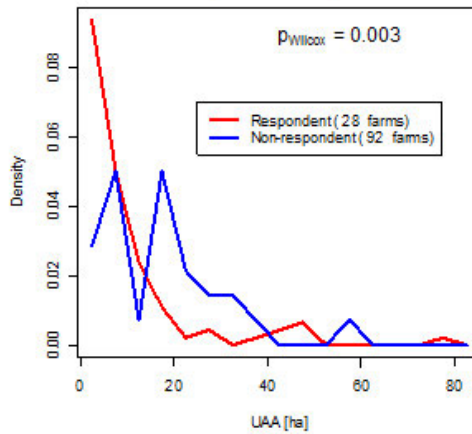

Andrew Howarth | VV Research Station Agroscope Hohenholz-Ferikon ARI
Petal Workshop Tallin, Oct 2-4, 2011

14



Dairying

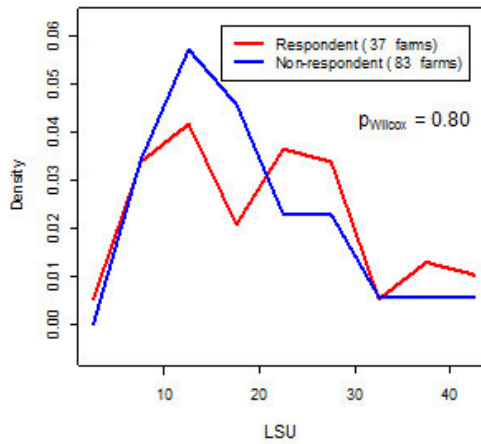

Andrew Hovewich | H Research Station Agroscope Hohenholz-Fankon AKI
Pastor Workshop Tallin, Oct 24, 2011

15

Agroscope



Switzerland: plain/ hilly/ mountain region

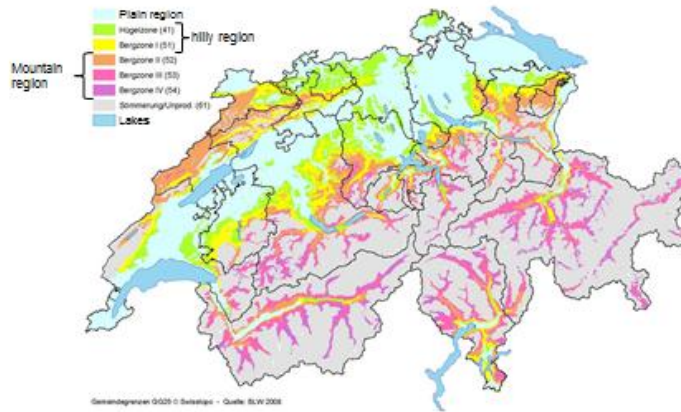

Andrew Hovewich | H Forschungsanstalt Agroscope Hohenholz-Fankon AKI
Wirtschaftliche Entwicklung der Schweizer Berggebiete | Agrarökonomie-Tagung 2009

16

Agroscope



Special crops

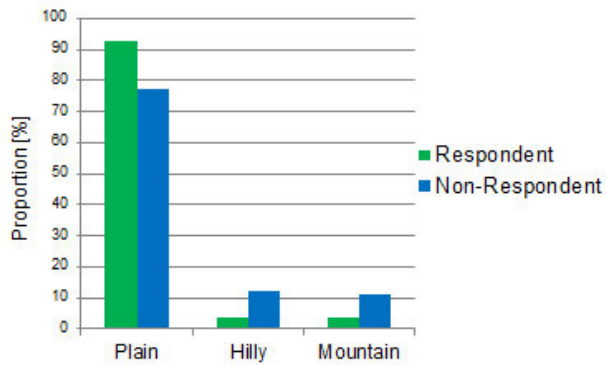

Andrew Hovewich | H Research Station Agroscope Hohenholz-Fankon AKI
Pastor Workshop Tallin, Oct 24, 2011

17

Agroscope



Dairying

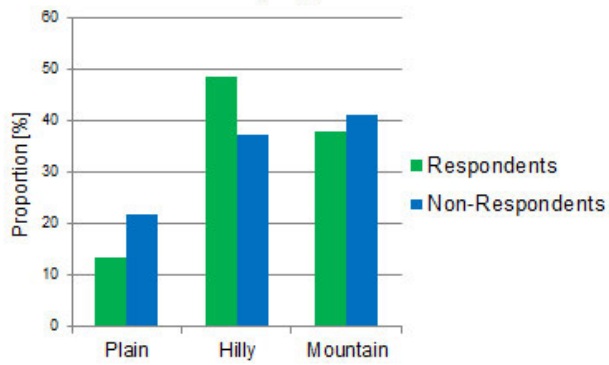

Andrew Hovach | H Research Station Agroscope Nendelnholz-Ferikon ARI
Petal Workshop Tallin, Oct 2-4, 2011



Affinity to future participation (65 holdings)

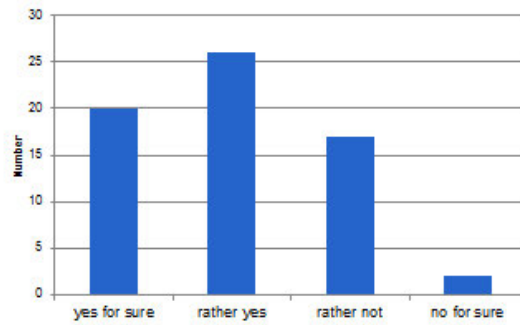

Andrew Hovach | H Research Station Agroscope Nendelnholz-Ferikon ARI
Petal Workshop Tallin, Oct 2-4, 2011



Fixed Assets (2010)

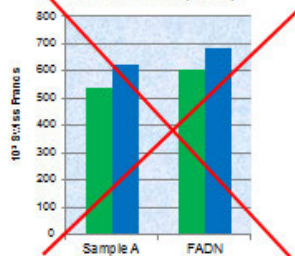

Poor data quality!
e.g. The balance sheet is off

Main reason:
➤ no quality control

➔ **Complete revision of the questionnaire**

Andrew Hovach | H Research Station Agroscope Nendelnholz-Ferikon ARI
Petal Workshop Tallin, Oct 2-4, 2011



Are External Assets fully comprised?

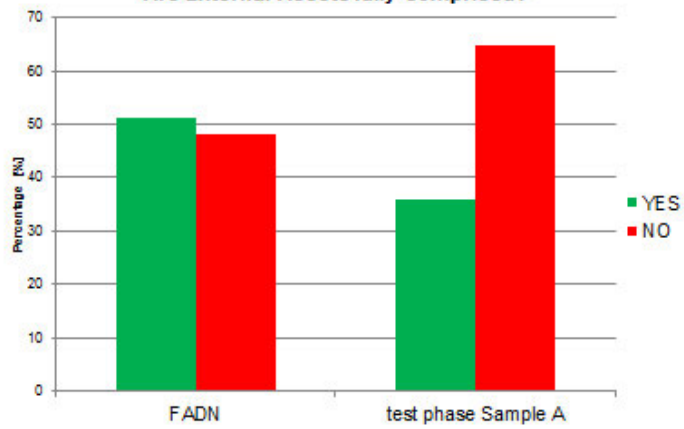

Private Consumption

Is the private consumption fully comprised?

yes: 69% no: 31%



- Collection of Private Expenses is
- demanding
 - error-prone
 - may lead to decreasing response rates



Summary

- ✓ **Random sampling**
- ✓ **Two samples** for meeting different requirements
- ✓ First test phase Sample A showed
 - Random sampling is **practicable**
 - **High Willingness** for participation (60%)
 - **Low response rate** of 27% (completed questionnaires)
 - Response behaviour between the two types „Dairying“ and „Special Crops“ as well the German-speaking and French-speaking part **differ**
 - **Poor Data quality** (worse for mailed questionnaires)
 - Forms: Fiduciaries do significantly better than farm managers
- ✓ First test phase Sample A provides valuable information on future improvements (-> 2nd test phase):
 - **Web-based** entry preferred
 - „Just-in-time“ **quality control**
 - Completion of form preferred by **fiduciaries**
 - **Simple financial accounting** preferred – omission of ambitious supplementary questions!



Thank you very much for your attention!



18 Technical innovation in the Dutch dairy sector

Pieter Willem Blokland

Technical innovation in the Dutch dairy sector

Author: Pieter Willem Blokland
Dutch Agricultural Economic Research Institute





Contents

- Aim of the study
- Adoption of innovation
- Structure of innovative dairy farms
- Financial results of innovative dairy farms
- Presence of durable goods on dairy farms





Aim of the study

- The aim of the study is to gain understanding about the adoption of innovations in the Dutch dairy sector
 - Differences between innovative and non innovative dairy farms
 - Can the presence of durable production goods on dairy farms be explained?



Structure of innovative dairy farms

■ Data

- Dutch FADN
- Innovation monitor of LEI
 - Survey FADN farms

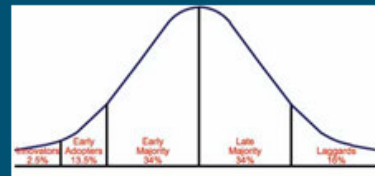

■ Selection of farms

- Innovators: first 16% to adopt durable good
- Non innovators: rest of the farms
- Farms present in FADN 2001-2004



The innovation monitor of LEI is a survey conducted at the Dutch FADN participants on a yearly basis. The innovation monitor reports the state of innovativeness and modernization of the Dutch farms. By using the FADN farms, the data of the monitor can be used in combination with the original FADN data.



The innovation monitor distinguishes three durable goods: milk robot, deep litter stable and automatic (animal) data recording.

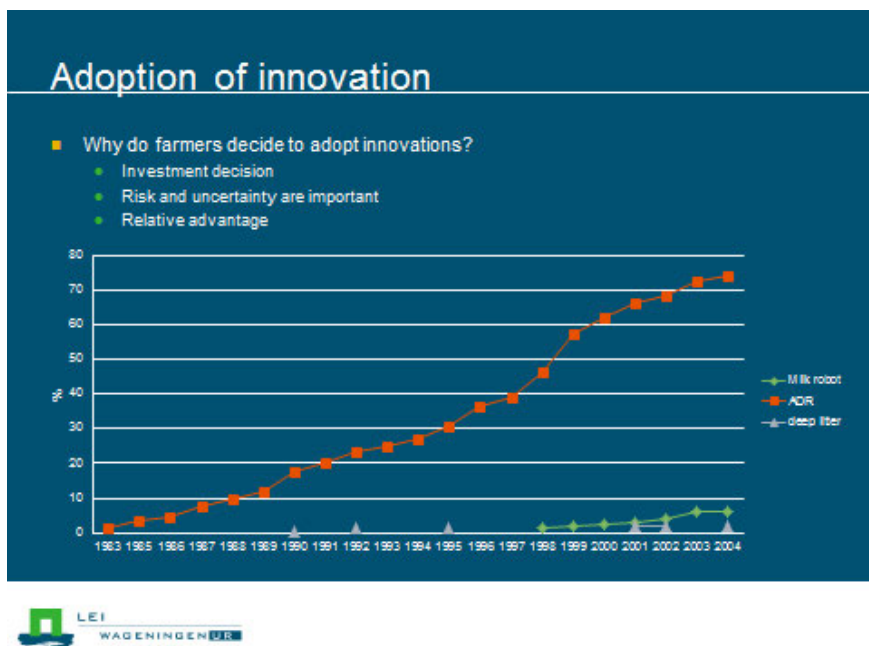

The figure shows the diffusion curve of the various durable goods. Almost 75% of the farms have adopted the automatic data recording system. About 8% of the farms adopted a milk robot and about 2% adopted a deep litter stable.

The adoption decision is mostly an investment decision, where risk and uncertainty are very important. The innovation has to have a relative advantage in comparison to the 'old' situation. For instance: if a milking robot increases labour productivity in comparison to a milking parlour, the milking robot has a positive relative advantage.

Structure of innovative dairy farms

■ Location of innovative and non innovative dairy farms

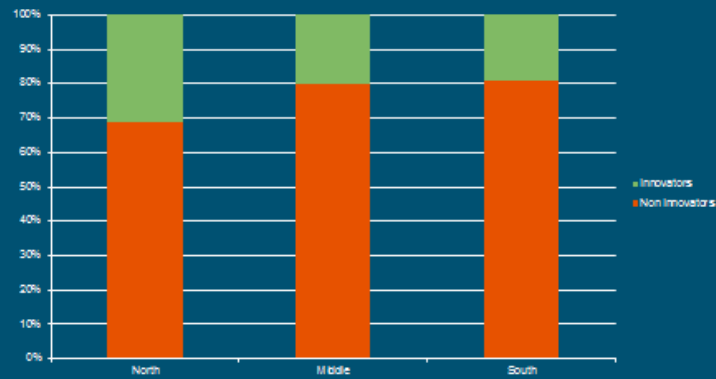

Structure of innovative dairy farms

Average milk quota

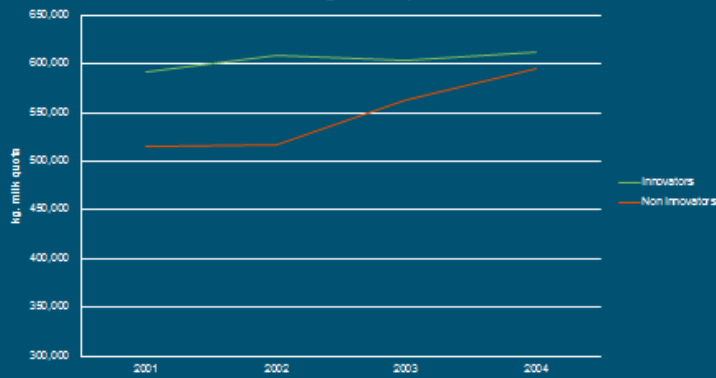

Structure of innovative dairy farms

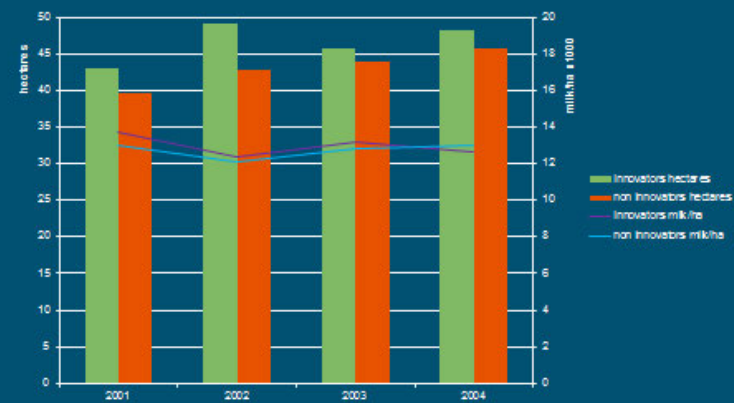

Financial results of innovative dairy farms



Financial results of innovative dairy farms

	Innovators	Non innovators
Assets (€ x1000)		
Intangible fixed assets	1.163	932
Fixed assets	1.297	1.280
Land	838	873
Buildings	169	144
Installations	12	10
Machines	84	58
Farmhouse	168	152
Other fixed assets	24	22
Other assets	251	287
Total Assets	2.711	2.459



Financial results of innovative dairy farms

	Innovators	Non innovators
Liabilities (€ x1000)		
Long term loans	658	529
Short term loans	41	28
Total liabilities	1.048	836
Owner equity	1.663	1.623
Total liabilities	2.711	2.459
Solvency (%)	61	66



Financial results of innovative dairy farms

■ Economic farm results (€ x1000), 2001-2004

	Innovators	Non innovators
Total revenues	225	220
Total costs (incl. calculated cost)	291	278
-paid cost and depreciation	158	151
-calculated labour and capital costs	133	127
Net farm result	-66	-58
Rate of return (%)	77	79



Despite the higher revenues of the innovators, they realize a lower net farm result. This is caused by the higher paid and calculated costs. Innovation does not necessarily mean better financial results.

Financial results of innovative dairy farms

■ Investments of dairy farms (2001-2004)

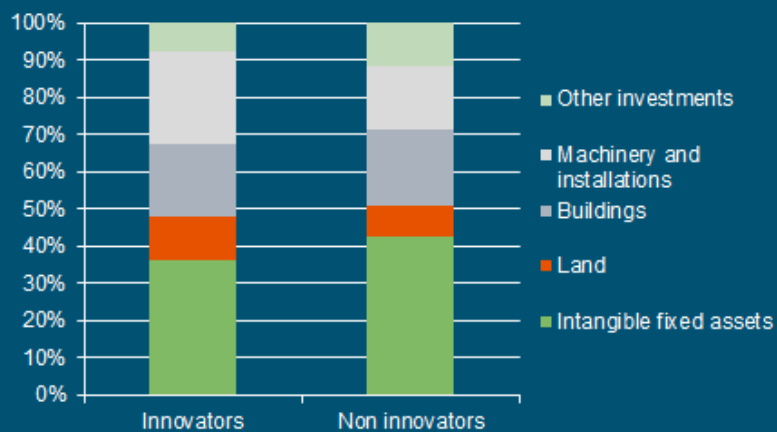

Non innovators invest more in intangible fixed assets (milk quota). The innovators invest more in machinery and installations.

Financial results of innovative dairy farms

Investments of dairy farms (2001-2004)

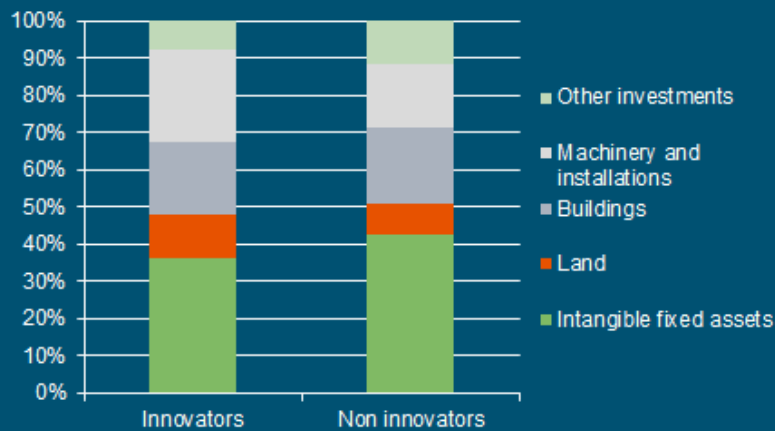

Presence of durable goods on dairy farms

Logistic regression

- Influence independent variables on a dichotomous variable
- Chance a durable good is on a farm

Independent variables:

- Farm size (ESU)
- Successor
- Age
- Labour
- Region



The presence (chance) of durable goods on dairy farms is estimated with logistic regression. Based on a theoretical frame work, five independent variables have been selected. Farm size, the presence of a successor, the age of the farmer, the labour intensity and the region in which the farm is located can have an effect on the presence of durable goods.

- Larger farm adopt innovations sooner than smaller farms
- Farms with a high labour intensity adopt innovations sooner than farms with a low labour intensity
- Young farmers will adopt innovations sooner than older farmers
- Farmers with a successor will adopt innovation sooner than farmers with no successor
- The region where the farm is located has influence on the adoption of innovations

Presence of durable goods on dairy farms



■ Presence is predicted by:

- Farm size
- Successor
- Age
- Middle region



The presence of either a milking robot, automatic data collection system or deep litter stable is predicted by: farm size, successor, age and located in the middle region.

Presence of durable goods on dairy farms



■ Presence is predicted by:

- Successor
- Age
- Middle region



The presence of an automatic data collection system is predicted by the presence of a successor, the age and the location of the farm in the middle region.

The presence of a milking robot and deep litter stable could not be separately analysed (low number of farms).

Conclusions

- Innovators have a lower solvability
- Innovators realise a lower rate of return
- Innovators invest more in machines and installations
- Age, successor, region and farm size are variables that can explain the adoption of innovations on Dutch dairy farms

19 Total calculation based on weighted farm level accounting data

Maria Yli-Heikkilä and Jyri Järvinen

The aim is to calculate weights for agricultural accounting data (FADN). The sample data consists of some 900 agricultural enterprises. Based on weighted accounting data aggregate economic indicators are calculated to show the average performance of the Finnish agricultural economy. The aggregate number of agricultural enterprises in Finland is about 60,000. The results are calculated national subsidy region wise.

We consider an upper unconstrained optimization problem where the objective function is a quadratic with its linear constraints as follows:

$$\begin{aligned} \arg \min_{\mathbf{x}} \quad & \mathbf{x}^T \mathbf{x} \\ \text{s.t.} \quad & \mathbf{x}^T \mathbf{a} = A, \\ & \sum_i X_i^T = b_i, \quad i = 1, \dots, 11, \\ & \mathbf{x}_n \geq 1, \quad n = 1, \dots, 965, \\ & \mathbf{x}, \mathbf{a} \in \mathbb{R}^n. \end{aligned}$$

Where:

- \mathbf{x} = weight vector
- A = total cultivated land
- \mathbf{a} = sample farms' cultivated land vector
- b_i = total # of farms in farm size class i
- i = farm size class
- n = # of agricultural enterprises in the sample data

The program is written in Matlab. It uses *fmincon* function with sqp (Sequential Quadratic Programming) algorithm for optimization.

The results can be validated by comparing them to yearly agricultural statistics produced by the Finnish Ministry of Agriculture and Forestry. As shown in Figures 19.1 and 19.2, the obtained solution goes well within the tolerance bounds with some 1% deviation. Also, the results look reasonable when compared to other national economic indicators as shown in Figures 19.3, 19.4 and 19.5.

$$n = \# \text{ of agricultural enterprises in the sample data}$$

The program is written in Matlab. It uses *fmincon* function with sqp (Sequential Quadratic Programming) algorithm for optimization.

The results can be validated by comparing them to yearly agricultural statistics produced by the Finnish Ministry of Agriculture and Forestry. As shown in Figures 19.1 and 19.2, the obtained solution goes well within the tolerance bounds with some 1% deviation. Also, the results look reasonable when compared to other national economic indicators as shown in Figures 19.3, 19.4 and 19.5.

Other resources of comparative real data for further validation of the method described here could be Economic Accounts of Agriculture from Statistics Finland, or Farm Structure Survey and Agricultural Census 2010 from Eurostat.

Figure 19.1 Number of farms by subsidy region

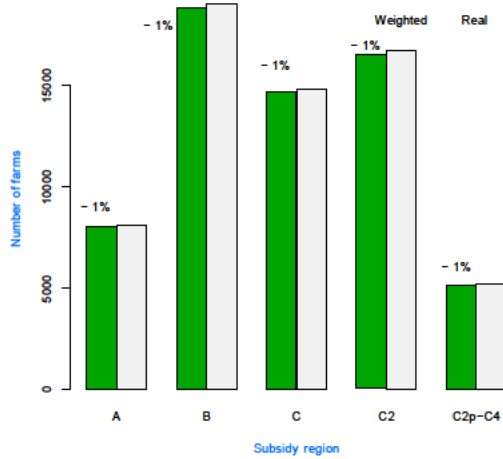

Figure 19.2 Cultivated land by subsidy region

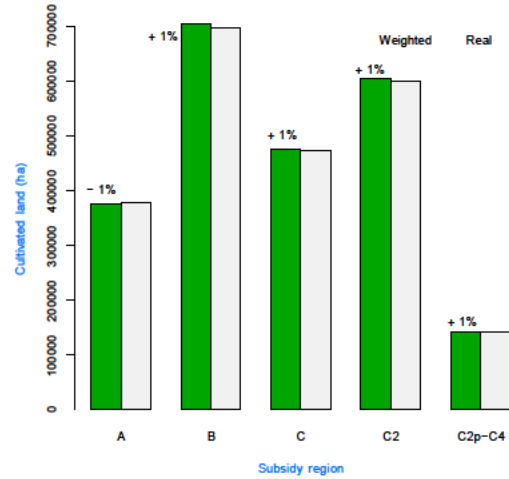

Figure 19.3 Number of farms by economic size

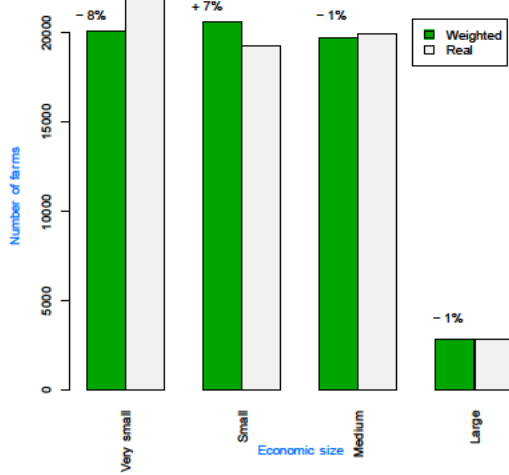

Figure 19.4 Cultivated land by type of farming

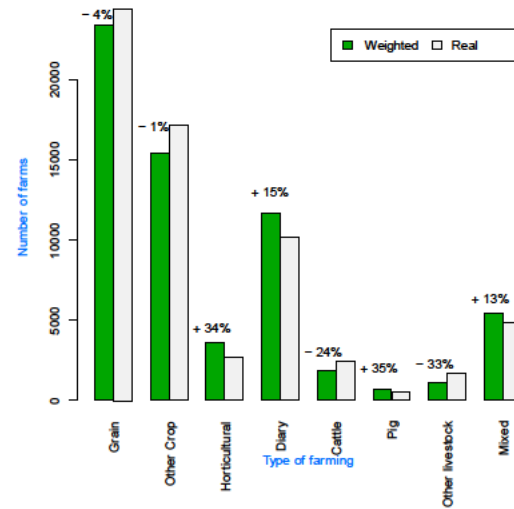
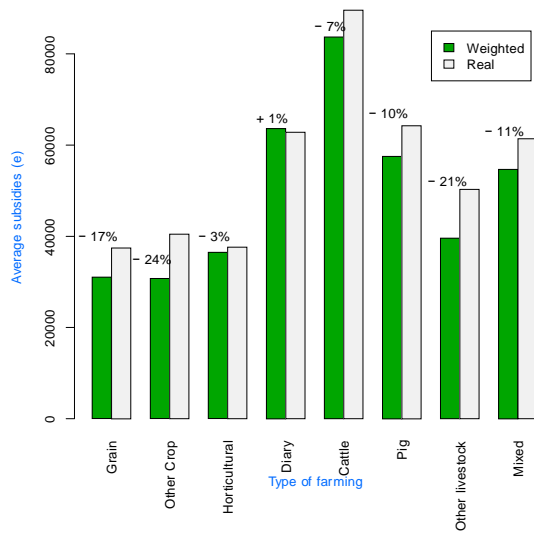
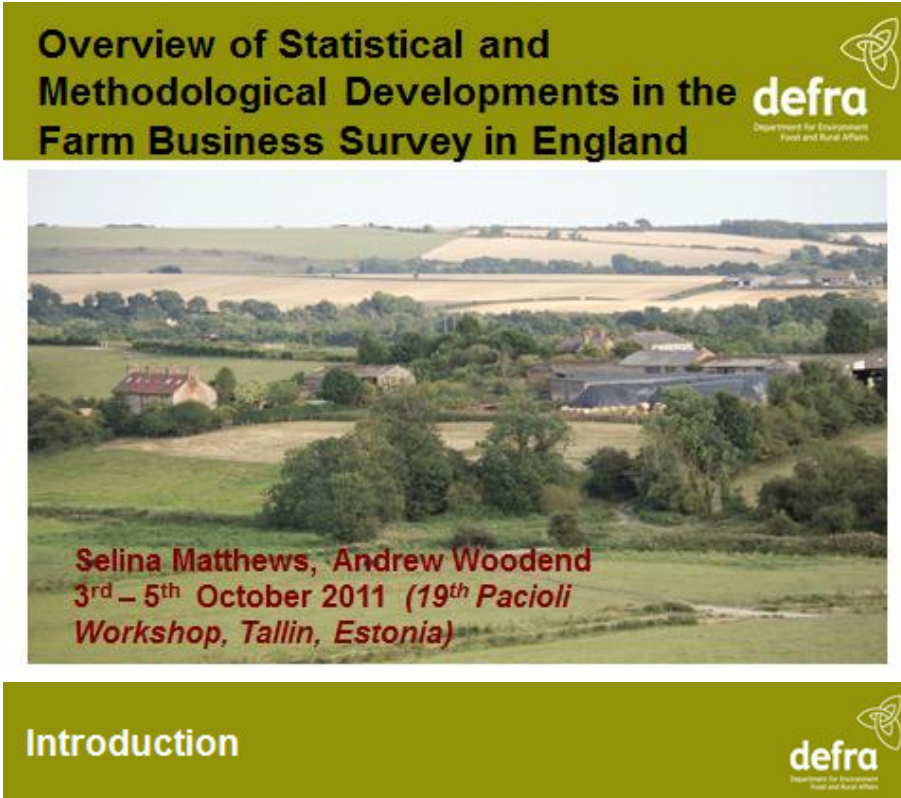

Figure 19.5 Average subsidies by type of farming



20 Overview of Statistical and Methodological Developments in the Farm Business Survey in England

Selina Matthews and Andrew Woodend



Overview of Statistical and Methodological Developments in the Farm Business Survey in England

defra
Department for Environment
Food and Rural Affairs

Selina Matthews, Andrew Woodend
3rd – 5th October 2011 (19th Pacioli
Workshop, Tallin, Estonia)

Introduction

defra
Department for Environment
Food and Rural Affairs

- Allocation of costs
- Household income
- Return on capital employed
- Miscellaneous statistical issues

Allocation of costs - background



- Policy interest in profitability of agriculture as distinct from the overall farm business
- Presentation of results based on 4 cost centres – agriculture, agri-environment activities, diversification, Single Payment
- Has enabled analysis basis of individual cost centres for policy development (e.g. LFA)

With decoupled payments there has been more interest in seeing how the farming element of farm businesses is performing.

Tables showing farm income data by cost centres introduced from the 2004/05 survey. Four cost centres are agriculture, agri-environment activities (i.e pillar 2 schemes), diversification and the single payment (pillar 1).

Issues



- Where to start?
- How to apportion costs such as repair and maintenance of buildings, hedge cutting, routine office tasks?
- How to ensure allocation is a reasonable reflection of reality?

Initially adopted mechanistic approach primarily using output as the basis for allocating costs agriculture picked up the bulk of any overhead costs such as the maintenance of machinery, hedging, property repairs, etc.

2008/09 revised the methodology to incorporate more direct allocation of costs (rather than relying totally on calculations) by the researchers and for the remainder to adopt different approaches for different categories of costs.

All allocated at a very low level of disaggregation, i.e. To each of the individual costs such as water, electricity, machinery repairs, rent, property repairs and across all the activities on the farm.

Once the data has been submitted to the central processing point variables are derived by aggregating each of the activities up into the various cost centres for both outputs and costs.

Allocation of costs – overall approach



Apportionment of costs based on:

- Researchers professional judgement
- Discussion with co-operator
- Mechanistic approach
- Carried out at enterprise level in most cases
- Accepted that not possible to achieve 100% accuracy

Categories of costs

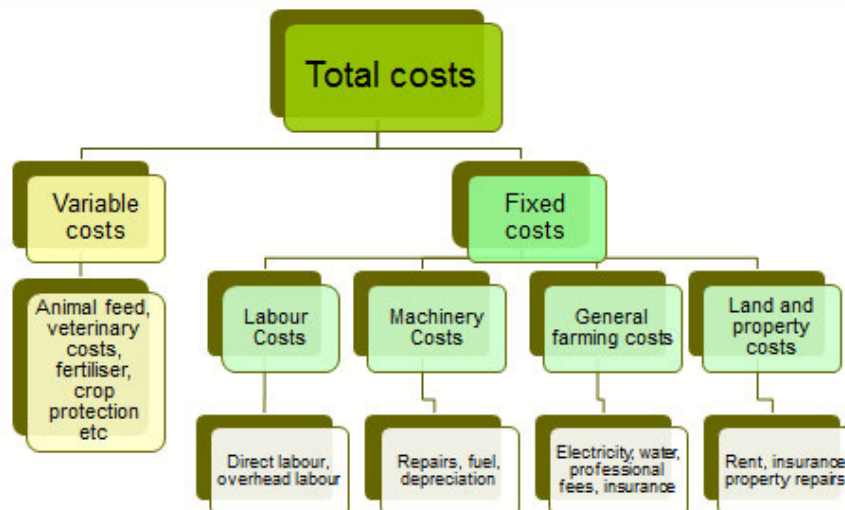

Five different categories of costs with a slightly different methodology for each category.

Variable costs are those costs that vary with the size and scale of the enterprise and will include costs such as animal feed, fertilisers, seed, sprays etc. These are allocated by the data collectors using information on invoices and in discussion with the farmer.

The fixed costs are more problematic - four categories; labour, machinery costs,(repairs, depreciation, running costs), general farming costs (electricity, heat, water, bank charges, professional fess) and land and property costs (rent, property insurance, property repairs).

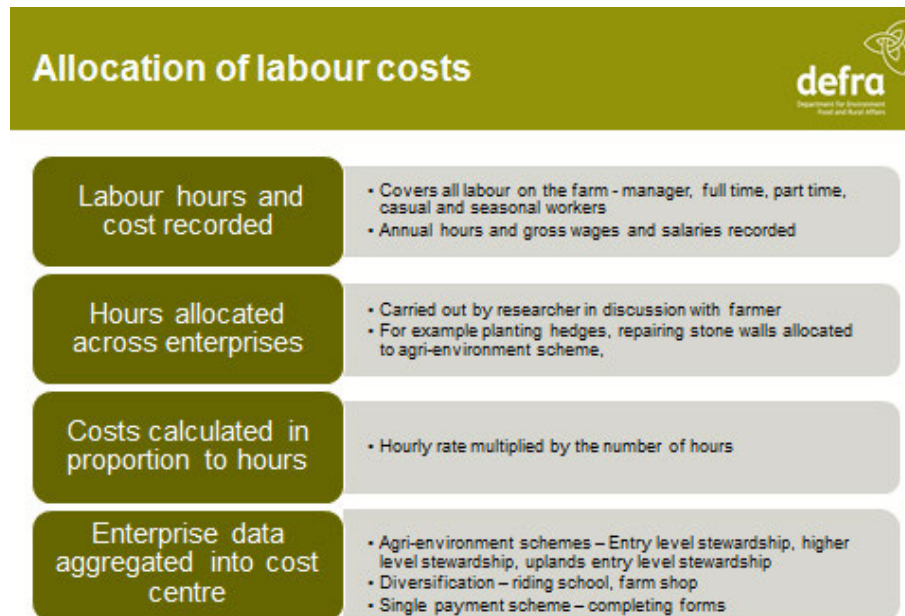

Labour costs are probably the most straight forward to allocate in as much that the recording form for the FBS already collects the hours and cost for each category of worker on the farm.

The researcher in discussion with the farmer allocates the hours across all the activities on the farm, level of overhead are included allocated pro-rate. E.g. if the farmer indicates that around 10% of the working time is spent on hedging, ditching, painting buildings, etc. the researcher will make sure that is factored into the allocation.

The hourly rate of pay is then multiplied by the number of hours to get the cost per activity.

Once the data is submitted variables are calculated by aggregating up related enterprises. For example work carried out on any of the agri-environment schemes will all feed into the agri-environment cost centre.

Allocation of machinery costs



Total machinery costs (A)	<ul style="list-style-type: none">• This will include repairs, fuel, maintenance, depreciation and insurance• Covers the whole farm business, all enterprises
Allocate known direct costs (B)	<ul style="list-style-type: none">• Known costs for all enterprises other than core farming activities• For example mowing machine used for public parks and grass margins
Calculate overhead element of machinery $(A-B)*11.3\%=C$	<ul style="list-style-type: none">• Coefficient applied to residual of total costs minus known costs (A-B)• Value of 11.3% used based on earlier economic research
Apply overhead costs (C) across non-farming enterprises	<ul style="list-style-type: none">• This is based on the output of the enterprises but some activities excluded (e.g. Insurance receipts, grants, trading bonuses)• Output is adjusted downwards for some enterprises• Residual allocated to agriculture

AE, SPS, and Rental Income allocation 'dampened down' to reflect their lower requirement of these activities for overhead machinery costs.

Overhead machinery costs to all other activities will be allocated on the basis of their full output. The proportion of total machinery costs defined as 'overhead' will draw upon previous research.

The following activities excluded from the apportionment of **overhead** machinery [Imputed farmhouse and imputed farm cottage rental income {320, 321, 340}, capital credits {940}, appropriate share of machinery grants {276}, appropriate share of glasshouse grants {277}, permanent crop establishment grants {274}, disaster aid {272}, FMD Distress donations {990}, Co-op trading bonuses {930}, Miscellaneous insurance receipts {950}].

Allocation of machinery costs



Total output	£250,000	Total overhead costs: ((Total machinery costs) - (direct costs allocated to SPS, diversified, agri-environment)) / 0.115
Total Machinery Costs	£50,000	
Total Overhead Costs	£ 5,345	

	Output	Allocated direct costs	Dampening coefficient	Dampened output	Machinery Overhead Costs	based on (dampened output / total activity / total output) * total overhead costs
Entry Level Scheme	5000	400	0.1	500	11	
Other agri-environment activities	3000	300	0.25	750	16	
Single Payment Scheme	25000	200	0.1	2500	53	
Diversification - Rental	2000	800	0.1	200	4	
Other diversified activities	6000	1000			128	
Agriculture	209000			209000	5132	

Total costs allocated to SPS, diversified and agri-environmental activities: 2913

Total machinery costs allocated to agriculture of which:	47087	Costs allocated to Agriculture: (Total machinery costs) - (Total costs allocated to SPS, diversified and agri-environmental activities)
overhead machinery costs	5132	
direct machinery costs	41955	

- ELS - one tenth of the output
- Other environmental schemes - a quarter of output
- SPS - one tenth of output
- Rental income activities - one tenth of output

Allocation of costs – general farming costs



- This will include items such as electricity, water, bank charges, road tax
- Known direct costs are allocated by Researcher to non-farming enterprises
- Residual allocated according to enterprise output but as previously some activities dampened down or excluded

Allocation of general farming costs: electricity

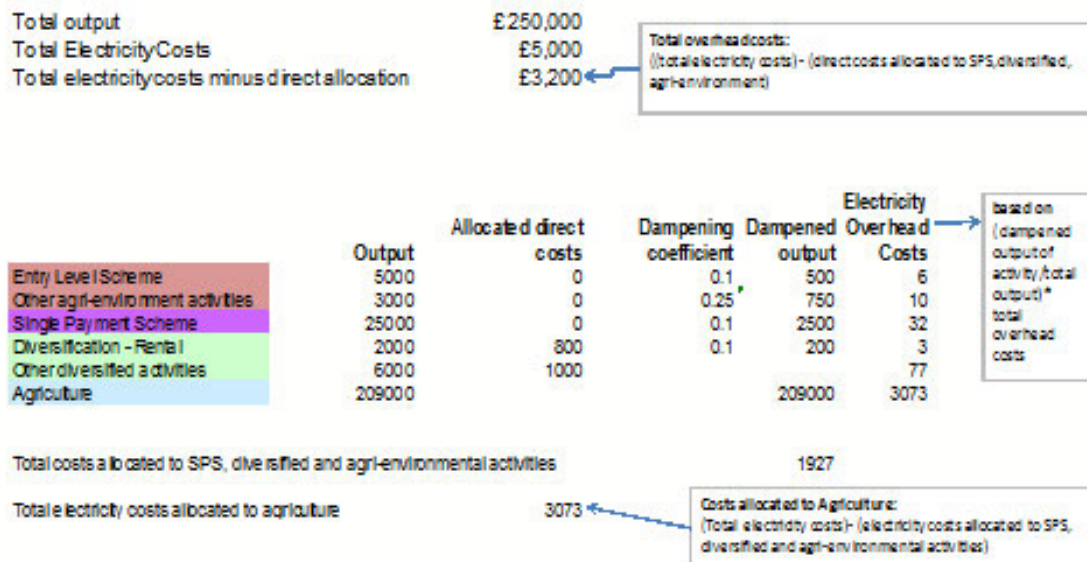

Allocation of costs – land and property costs, occupiers expenses



- Any known costs e.g. those specific to AE schemes are allocated by the Researcher
- Rent allocated directly only to diversified activities with income bearing assets
- Remainder allocated on basis of the gross margin for agriculture, agri-environment, diversification and single payment cost centres

Land and property costs allocated by researcher as far as possible, remainder allocated on basis of GM. At GM level farmer decides which, and whether, to grow crops or produce livestock products, or not undertake any Agriculture activity. As the level of Agriculture activity falls on a farm, the allocation of land and property costs would increasingly fall on the SPS cost centre if the farm business only undertook Agriculture and SPS activities. The logical conclusion being that if a farmer ceased Agriculture production, all land and property costs would be apportioned to the SPS cost centre; if a farmer used only a small

area of a farm for Agriculture and the majority under SPS without production, the majority of land and property costs would be apportioned to SPS. In typical examples, where all land is used for Agriculture, SPS (and AE), the majority of land and property costs would be apportioned to Agriculture unless the GM derived from Agriculture was particularly low.

Allocation of costs- property repairs

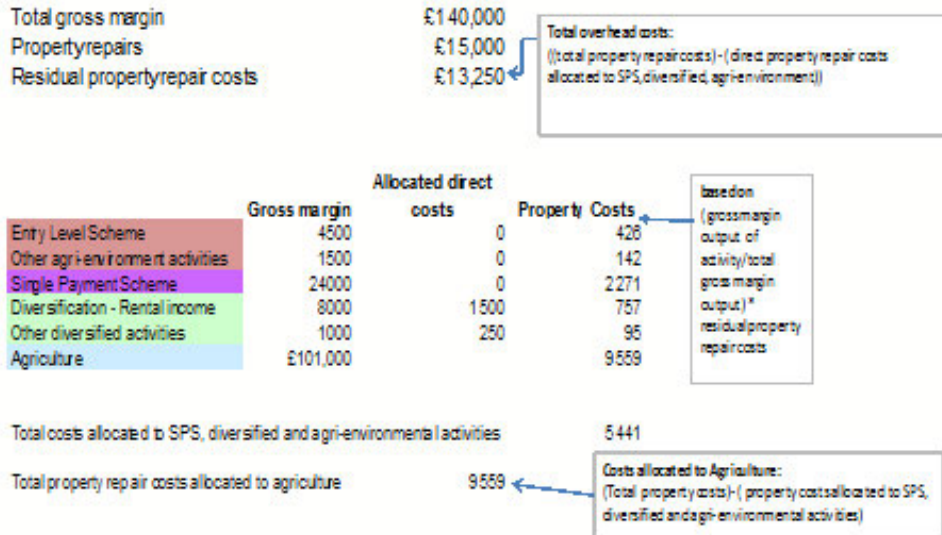

Breakdown of Farm Business Income by cost centre, cropping farms 2009/10

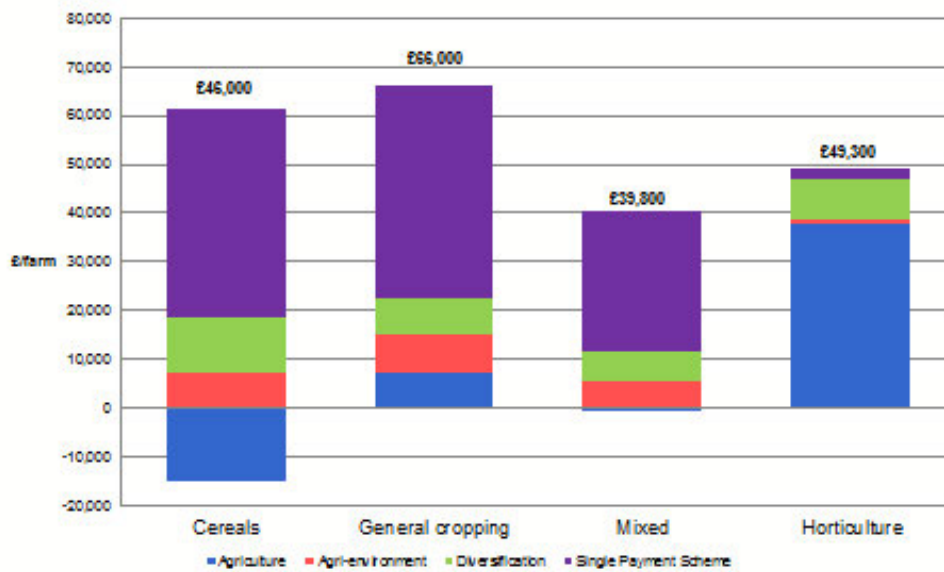

Breakdown of Farm Business Income by cost centre, livestock farms 2009/10

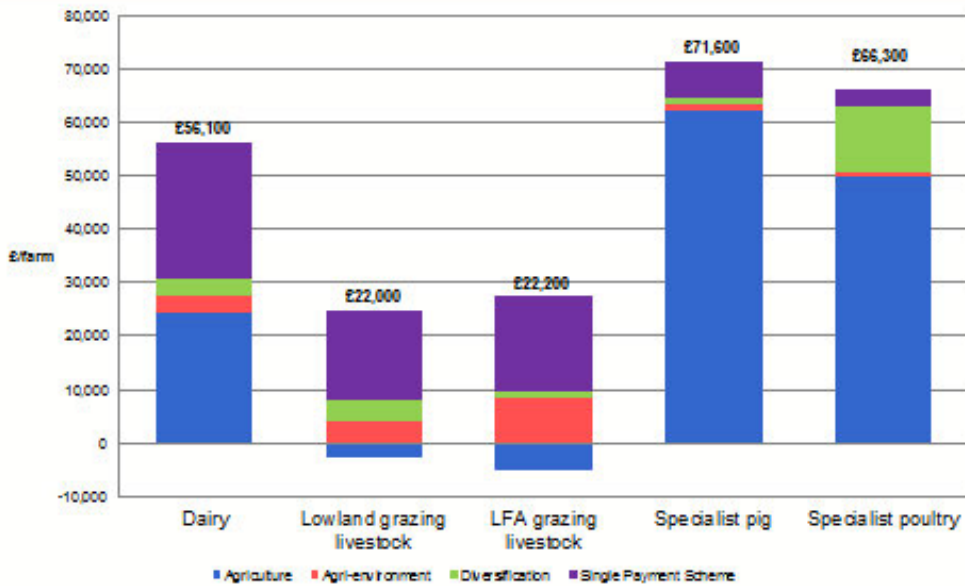

Farm Business Survey



Andrew Woodend, 3rd – 5th October 2011
(19th Pacioli Workshop, Tallin, Estonia)

Farm Business Survey: Household income on farms in England



Household income = farm income (incl diversification) + off-farm income

- 69% of farm household income in 2009/10 was from the farm.
- Average = £47,400/household (£55,600/household in 2008/09).
- 3 years to 2009/10, > 25% of farm households had income < £20,000.
- Around 7% of the farm population entirely dependent on farm.
- Where low farm profit, more off-farm income.
- We can compare household incomes of farmers with other households.

Household income on farms in England contd



- 3 years to 2009/10, farm household income > all households; and in two years it was greater than the average for self-employed households.
- Always a greater income range between top fifth and bottom fifth within the farm household population than in the all household population.
- Top fifth household incomes higher in farming than outside.
- Average income for the bottom fifth of farm households is broadly in line with the average income for the bottom fifth of all households, but below that for the bottom fifth of self-employed households.

Return on capital employed



- After charging for all costs (including imputed rent on owned land and cost of farmer's own labour) the median farm earns 0% return on its capital
- Extremely large range, but return is often poor. Many farms make a negative return - some farms not motivated by profitability?
- Average profitability per unit of capital increases with the size of the farm.
- Relative to wealth, debt in farming is low. Some farms may have been under investing while their asset base has been appreciating via the market.
- All farming sectors have considerable scope to lift economic performance

Some statistical issues in the Farm Business Survey: recruitment to survey



- FBS is England's source of FADN farm records data. Sample is 2,000 farms out of a field of survey of 60,000 farms.
- For recruitment into the survey, sample stratified by farm type and location. Therefore hopefully no, or very little, 'first order' bias.
- But we also need to satisfy ourselves that there is no 'second order' bias, eg if some farm types are much keener to join the survey than others.
- Valuable comparator is 'June Survey' of the population (census in 2010).
- We can check for any bias in the FBS by matching to the June data.

Some statistical issues in the Farm Business Survey: recruitment to survey



- We will look at the FBS sample and identify;
 - (i) farms approached for recruitment, and the recruitment outcome
 - (ii) continuing members, by years in the survey, and
 - (iii) farms that have recently left the FBS
- In each of these three areas we can also see how the FBS compares with the actual ('June') population. (Good opportunity in 2010 as census year).
- For example, looking at farms refusing to join the FBS will show if certain farm types more likely to join the FBS than others.
- Any non-response bias might be important, (low recruitment level – 10%).
- This is a low rate, and, given that the initial recruitment sample is not randomly selected but based on quotas, is a potential source of bias.

Some statistical issues in the Farm Business Survey: panel effect



- FBS is a panel-based survey & many farms are in it for at least 15 years.
- Possible bias related to panel-based surveys like the FBS:
 - (i) population change not captured by the sample and
 - (ii) changes over time due to *being* in the sample.
 - A panel survey needs annual replenishment to keep up with changes in the population, eg new entrants to farming.
 - However, farming community is slow to change and FBS sample quotas can reflect population change.
 - Therefore, the FBS sample evolves via the sample quotas and the fact that farm businesses within the panel will also evolve.

Some statistical issues in the Farm Business Survey: panel effect



- Also a '15 year rule' to ensure a certain level of sample change
- Annual rate of exit is slightly higher than 7% expected via 15 year rule.
- Also higher than the natural rate of exit from farming in actual population.
- Comparison with population data, eg are those in FBS for a longer time any different to population for key June variables, (eg area farmed)
- One further potential problem: Businesses could, in theory, improve performance as a result participation in the FBS.
- However it is equally plausible that any farmers can use their own financial records and react to them, even if they are *not* in the FBS.

Some statistical issues in the Farm Business Survey: panel effect



- To see if any risk of panel-related bias we model the FBS data to see whether time in the panel is correlated with certain variables, eg income.
- If 'yes', the nature of the relationship with 'time in panel' would highlight if further extension beyond 15 years would increase bias.
- One other analysis on impact of time in panel is to compare change across years for recent entrants to the FBS against 'older members'. Does size of annual change (in say farm area) reduce (or increase) with time in the FBS? Again it is important to check same in actual population.
- **Summary: nature of FBS (low recruitment rate, panel), makes it vital to regularly review the sample: non-response, recruitment, membership, exit. Comparison with actual population is crucial.**
- **Comparison impossible? - eg income - vital to monitor in the sample.**

21 Unit Cost calculation based on FADN-data (77 products/530 cost items)



19th PACIOLI –workshop
Tallinn (Estonia, 2nd-5th of October 2011)

Unit Cost calculation based on FADN-data

Arto Latukka
MTT Economic Research, Finland

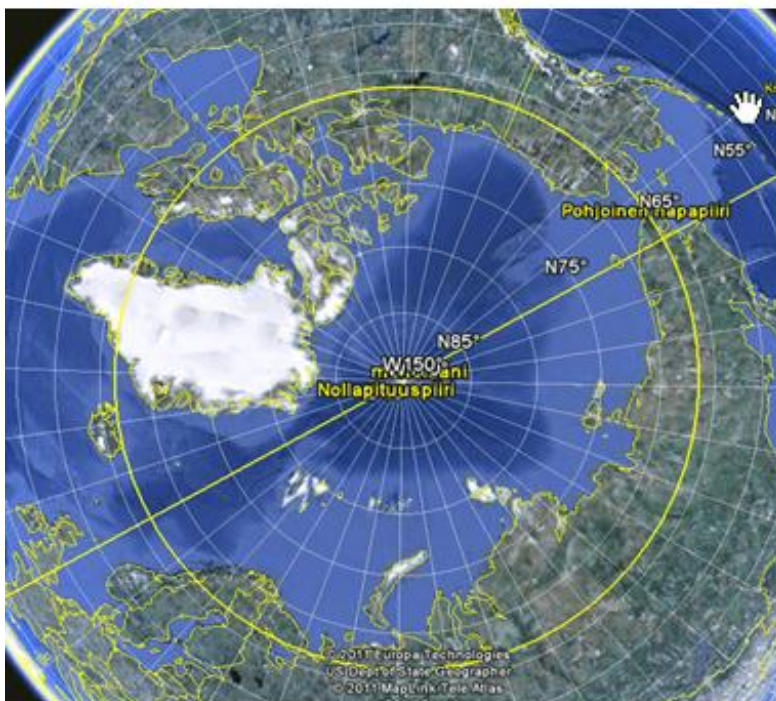

Unit cost of milk, provisional results



Unit cost	2008						
	Milk						
	Dairy Farms						
	Extremely large	Very large	Large	Rather large	Average size	Rather small	Average
Farms represented	260	770	3 600	3 070	2 790	860	11 400
Farms in sample	30<cn<40	60<cn<70	130<cn<140	70<cn<80	40<cn<50	0<cn<6	350<cn<360
Production Cost	386.476	266.890	156.137	104.895	75.027	48.605	126.904
Production volume	767.615	485.785	265.261	152.787	99.661	50.439	204.168
Unit Cost	0.503	0.549	0.589	0.687	0.753	0.964	0.622
Seed cost *100	0.00	0.00	0.00	0.00	0.00	0.00	0.00
Fertilizer*100	0.00	0.00	0.00	0.00	0.00	0.00	0.00
Lime	0.00	0.00	0.00	0.00	0.00	0.00	0.00
Crop Protection	0.00	0.00	0.00	0.00	0.00	0.00	0.00
Electricity	0.64	0.55	0.47	0.59	0.64	0.81	0.55
Drying	0.00	0.00	0.00	0.00	0.00	0.00	0.00
Fuel and lubricants	0.03	0.03	0.03	0.03	0.03	0.02	0.03
Heating	0.07	0.16	0.10	0.10	0.15	0.01	0.11
Labour cost	12.90	12.72	20.87	30.27	35.18	53.42	23.11
Rents paid	0.00	0.00	0.00	0.00	0.00	0.00	0.00
Livestock purchasing	0.10	0.12	0.27	0.19	0.33	0.00	0.22
Livestock transfers	5.69	7.41	4.91	4.85	5.18	2.01	5.35
Forage costs paid	8.91	8.55	8.27	7.86	9.03	13.11	8.47
Forage cost of own fodder	9.90	11.73	14.92	17.74	19.23	21.66	15.19
Depreciation and interests of Machinery	4.00	4.73	2.55	2.07	1.74	0.82	2.80
Depreciation and interests of Buildings	6.12	6.78	4.29	2.61	1.56	1.62	4.13
Depreciation and interests of construction	0.00	0.00	0.00	0.00	0.00	0.00	0.00
Interest costs of other assets	1.86	1.98	2.03	2.18	2.13	2.82	2.06

User interface of Unit cost web (will be published in mtt.fi/economydoctor)

Unit cost Averages [Logout](#) [Change password](#)

Select a manner of representation and a variable for the base of the 'weak vs. strong' comparison

Only averages

Select up to five classifiers and their values and Generate report

Multiple classifiers can be selected by holding down CTRL key on keyboard while selecting

1. Classifier

Accounting year > 2008 [Change option](#)

2. Classifier

Production type > Dairy Farms [Change option](#)

3. Classifier

Product > Milk [Change option](#)

4. Classifier

Subsidy Region	Small
County	Rather small
FADN Region	Average
Economic size	Rather large
Rural Areas	Large
Region (Nuts2)	Very large
Production method	Extremely large

Select additional classifier

Select all

Generate report

1998-2008e 2007 2006 2005 2004 2003 2002 2001 2000 **Own criteria** Info

Own Criteria

Begin with selecting report

Unit cost | Averages | [Logout](#) [Change password](#)

Select a manner of representation and a variable for the base of the 'weak vs. strong' comparison

Only averages |

Select up to five classifiers and their values and Generate report

Multiple classifiers can be selected by holding down CTRL key on keyboard while selecting

1. Classifier

Accounting year	MK
Subsidy Region	Sucker cow
County	Male cattle >2y
FADN Region	Male cattle 1-2y
Production type	heifers >2y slaughter
Economic size	heifers >2y
Rural Areas	heifers 1-2y
Region (Nuts2)	Calves
Production method	Calves slaughter
Product	Boar

Service Production: MTT Agrifood Research Finland | www.mtt.fi/english

Begin with selecting report

Unit cost | Averages | [Logout](#) [Change password](#)

Select a manner of representation and a variable for the base of the 'weak vs. strong' comparison

Only averages |

Select up to five classifiers and their values and Generate report

Multiple classifiers can be selected by holding down CTRL key on keyboard while selecting

1. Classifier

Accounting year > 2008 [Change option](#)

2. Classifier

Production type > Dairy Farms [Change option](#)

3. Classifier

Product > MK [Change option](#)

4. Classifier

Subsidy Region	Subsidy Region A
County	Subsidy Region B
FADN Region	Subsidy Region C1
Economic size	Subsidy Region C2
Rural Areas	Subsidy Region C2p
Region (Nuts2)	Subsidy Region C3
Production method	Subsidy Region C4

Unit cost of milk, provisional results



Unit cost	2008					
	Milk					
	Dairy Farms					
	Subsidy Region C2p	Subsidy Region C2	Subsidy Region C1	Subsidy Region B	Subsidy Region A	Average
Farms represented	590	4 960	2 510	1 810	430	10 300
Farms in sample	15<n<20	150<n<160	80<n<90	30<n<40	15<n<20	310<n<320
Production Cost	99.592	134.265	121.308	120.813	141.471	127.067
Production volume	146.851	216.021	201.362	195.364	272.429	207.232
Unit Cost	0.678	0.622	0.602	0.618	0.519	0.613
Seed cost *100	0.00	0.00	0.00	0.00	0.00	0.00
Fertilizer*100	0.00	0.00	0.00	0.00	0.00	0.00
Lime	0.00	0.00	0.00	0.00	0.00	0.00
Crop Protection	0.00	0.00	0.00	0.00	0.00	0.00
Electricity	0.71	0.51	0.55	0.56	0.56	0.54
Drying	0.00	0.00	0.00	0.00	0.00	0.00
Fuel and lubricants	0.03	0.03	0.03	0.03	0.03	0.03
Heating	0.25	0.09	0.11	0.13	0.06	0.11
Labour cost	24.82	21.97	23.28	24.75	19.94	22.74
Rents paid	0.00	0.00	0.00	0.00	0.00	0.00
Livestock purchasing	0.39	0.22	0.28	0.19	0.00	0.22
Livestock transfers	5.09	5.45	5.07	5.64	3.90	5.29
Forage costs paid	9.82	8.79	7.82	7.02	7.13	8.22
Forage cost of own fodder	16.31	15.96	13.78	14.13	12.73	14.98
Depreciation and interests of Machinery	2.45	2.77	3.02	2.78	2.25	2.79
Depreciation and interests of Buildings	5.15	4.14	4.14	4.43	3.38	4.19
Depreciation and interests of construction	0.00	0.00	0.00	0.00	0.00	0.00
Interest costs of other assets	2.67	2.09	2.06	2.00	1.91	2.08

Begin with selecting report

Unit cost Averages [Logout](#) [Change password](#)

Select a manner of representation and a variable for the base of the 'weak vs. strong' comparison

Only averages

Select up to five classifiers and their values and Generate report

Multiple classifiers can be selected by holding down CTRL key on keyboard while selecting

1. Classifier

Accounting year > 2008 [Change option](#)

2. Classifier

Product > Barley , Oats [Change option](#)

3. Classifier

Subsidy Region	Cereal Farms
County	Other Crop Farms
FADN Region	Horticultural Farms
Production type	Dairy Farms
Economic size	Cattle Farms
Rural Areas	Pig Farms
Region (Nuts2)	Other Farms
Production method	Mixed Farms

Select additional classifier

Select all

Generate report

Unit cost	2008					
	Oats			Barley		
	Dairy Farms	Cereal Farms	Average	Dairy Farms	Cereal Farms	Average
Farms represented	5 580	14 400	20 000	5 630	11 100	16 700
Farms in sample	200<n<210	90<n<100	300<n<310	200<n<210	110<n<120	310<n<320
Production Cost	10,296	15,044	13,719	11,478	23,453	19,425
Production volume	34,247	43,301	40,775	36,762	69,588	58,546
Unit Cost	0.301	0.347	0.336	0.311	0.337	0.332
Seed cost *100	1.58	0.82	1.00	1.98	1.00	1.20
Fertilizer*100	1.87	2.57	2.40	1.89	2.56	2.42
Lime	0.79	0.20	0.34	0.84	0.22	0.35
Crop Protection	0.53	1.19	1.04	0.62	1.16	1.04
Electricity	1.22	0.76	0.87	1.28	0.60	0.74
Drying	0.60	0.91	0.84	0.66	0.58	0.60
Fuel and lubricants	3.21	2.69	2.81	3.32	2.58	2.78
Heating	0.34	0.28	0.30	0.35	0.24	0.26
Labour cost	5.99	12.88	11.26	6.03	10.57	9.61
Rents paid	1.56	1.03	1.16	1.40	1.26	1.29
Livestock purchasing	0.00	0.00	0.00	0.00	0.00	0.00
Livestock transfers	0.00	0.00	0.00	0.00	0.00	0.00
Forage costs paid	0.00	0.00	0.00	0.00	0.00	0.00
Forage cost of own fodder	0.00	0.00	0.00	0.00	0.00	0.00
Depreciation and interests of Machinery	8.38	7.15	7.44	9.17	8.84	8.91
Depreciation and interests of Buildings	0.82	0.37	0.48	0.78	0.61	0.65
Depreciation and interests of construction	0.00	0.00	0.00	0.00	0.00	0.00
Interest costs of other assets	3.14	3.70	3.57	2.59	3.24	3.10

Provisional results

Products in the unit cost calculation



Milk	Rye	Onion
Suckler cow	Winter wheat	Carrot
Bull >2v	Spring wheat	Redbeet
Bull 1-2v	Barley	Cabbage
Heifer, slaughtering	Malt barley	Strawberry
Heifer >2	Oats	Currant
Heifer 1-2	Mixed cereal	Raspberry
Calves	Green cereal	Apple
Calves, slaughtering	Other cereal	Ornamental plants
Boar	Pea for food	Cut flowers
Sow	Feed pea	Other open land crops
Other pig	Industry pea	Leaf vegetables, outdoor
Fattening pig	Other protein crop	cucumber, fresh pea
Piglet	Oilseed	Tomato
Hens	Oilflax	Cucumber
Chicks	Fibre crops	vegetables under glass
Broiler	Food potatoes	Cut flowers
Other poultry	Starch potatoes	Bulbs
Breeding goat	Sugarbeet	Potted flower
Other goat	Hay	Other greenhouse crop
Ewe	Silage	Mushrooms
Other sheep	Fedried silage	
Finnish horse	Pasture	
Thoroughbred horse	Feed maize	
Foal	Timothy seed	
Other equine	Cumin	
Other animal	Red canary grass	
Manure	Other crop	
	Fallow land	
	Other area	

Classifier (10), combinations can be selected



Accounting year Subsidy Region County FADN Region Production type Economic size Rural Areas Region (Nuts2) Production method Product	2009 2008 2007 2006 2005 2004 2003 2002 2001 2000	Accounting year Subsidy Region County FADN Region Production type Economic size Rural Areas Region (Nuts2) Production method Product	Subsidy Region Subsidy Region Subsidy Region Subsidy Region Subsidy Region Subsidy Region Subsidy Region	Accounting year Subsidy Region County FADN Region Production type Economic size Rural Areas Region (Nuts2) Production method Product	Region Southern Region Western F Region Eastern F Region Oulu Region Lapland
Accounting year Subsidy Region County FADN Region Production type Economic size Rural Areas Region (Nuts2) Production method Product	Region Etelä-Suomi Region Sisa-Suomi Region Pohjanmaa Region Pohjois-Suomi	Accounting year Subsidy Region County FADN Region Production type Economic size Rural Areas Region (Nuts2) Production method Product	Cereal Farms Other Crop Far Horticultural Fa Dairy Farms Cattle Farms Pig Farms Other Farms Mixed Farms	Accounting year Subsidy Region County FADN Region Production type Economic size Rural Areas Region (Nuts2) Production method Product	Small Rather small Average Rather large Large Very large Extremely large
Accounting year Subsidy Region County FADN Region Production type Economic size Rural Areas Region (Nuts2) Production method Product	Urban centres Urban-adjacent rural an Rural heartland areas Sparsely populated rural	Accounting year Subsidy Region County FADN Region Production type Economic size Rural Areas Region (Nuts2) Production method Product	Southern Finla Western Finla Eastern Finlan Northern Finla	Accounting year Subsidy Region County FADN Region Production type Economic size Rural Areas Region (Nuts2) Production method Product	Milk Suckler cow Male cattle >2y Male cattle 1-2y Heifers >2y slaug Heifers >2y Heifers 1-2y Calves Calves slaughter Boar

Unit Cost calculation



- 78 Products
- 536 Cost Items
- 950 Farms per accounting year
- 10 years (2000-2009), 9 500 farms
- Unit Costs and their structure are calculated
- Results can be observed by using 10 different classification factors (regions, production type, size class,..) and their combinations
- Results are going to be published in Economy Doctor internet site (www.mtt.fi/EconomyDoctor)

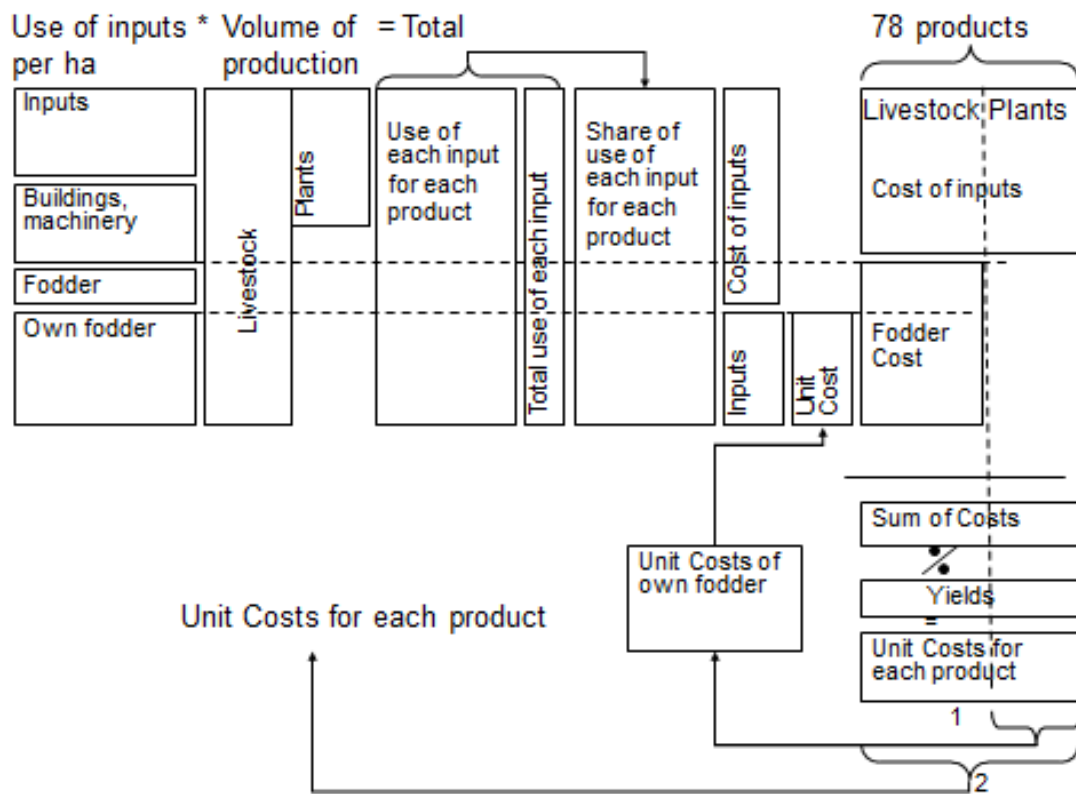

Allocation of some inputs to products.

Use of inputs per hectare and per cow / suckler cow



	Cow	Suckler cow	Barley	Oats	Silage	..
Seed			41	36	9	
Fertilizer			435	439	950	
Lime			0,25	0,25	0,08	
Crop Protection			1	1	0,5	
Electricity	1	0,2	1	1	1	
Drying costs			1	1		
Fuel and lubricants	0,20	0,20	9,40	9,40	10,00	
Heating	1	0,5	1	1		
Labour cost	120	40	12	12	12	
Rents paid			1	1	1	
Tractors (interest costs, depreciation)	0,2	0,2	8	8	10	
Combine harvesters (")			1,4	1,4		
Plows (")			1	1	0,3	
Planters (")			1	1	0,3	
...						
...						

- Farm level cost allocation will be used in future

Benchmarking (will be included in the future)

MTT

1998-2008e 2007 2006 2005 2004 2003 2002 2001 2000 Own criteria

Own Criteria

Unit costs for own farm (benchmarking)

Begin with selecting report

Unit cost Averages [Logout](#) [Change password](#)

Select a manner of representation and a variable for the base of the 'weak vs. strong' comparison

Only averages

Select up to five classifiers and their values and Generate report

Multiple classifiers can be selected by holding down CTRL key on keyboard while selecting

1. Classifier

Accounting year	2008
Subsidy Region	2007
County	2006
FADN Region	2005
Production type	2004
Economic size	2003
Rural Areas	2002
Region (Nuts2)	2001
Production method	2000
Product	1999

Select additional classifier

Select all

Generate report

Own Criteria

Selection of weak/strong –groups based on arable land (will be included in the future)

Begin with selecting report

Unit cost Averages [Logout](#) [Change password](#)

Select a manner of representation and a variable for the base of the 'weak vs. strong' comparison

Also weak/strong -groups Economic Size
Economic Size
Arable land

Select up to five classifiers and Generate report

Multiple classifiers can be selected by holding down CTRL key on keyboard while selecting

1. Classifier

Accounting year	2008
Subsidy Region	2007
County	2006
FADN Region	2005
Production type	2004
Economic size	2003
Rural Areas	2002
Region (Nuts2)	2001
Production method	2000
Product	1999

Select additional classifier

Select all

Generate report



Thank you for your attention

Arto Latukka
MTT Economic Research, Finland
arto.latukka@mtt.fi, +358 400 752010

22 Proposal for the enhancement of the EU FADN

Bernd Kuepker



**Proposal for the enhancement
of the EU-FADN**
European Commission DG AGRI L.3.

19th PACIOLI-workshop
Tallinn, 2.– 5. of October, 2011



What is the EU-FADN?

- The EU-FADN is an annual survey carried out by the Member States of the EU, based on the collection of accountancy data from a representative sample of EU agricultural holdings
- EU-FADN not equal to the national FADN
- Current sample ~ 81 000 holdings representing ~ 5,400,000 farms, up to 92 % of EU Agricultural Area around 97 % of EU agricultural production
- Time series available from 1989
- For each holding: General Information, Land Use, Labour, Livestock, Costs, Assets, Debts, VAT, Grants and subsidies, Crops and other products, Quotas
- Focus on farm income



Unit L3 2

What is our role?

- **Coordinate the data collection**
 - Definition of variables to be collected
 - Support the MS
- **Check quality of data**
- **Analysis**
 - Support the decision making of the EU-institutions with quantitative evidence
- **Steer the development**
 - Make sure that relevant data is collected
 - Propose adjustments to meet policy need

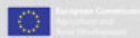

Unit L3

3

Why a new farm return ?

- The objectives of the CAP have broadened significantly
- Scope of the FADN should be enlarged to reflect these changes
- Need more data to provide better answers to questions related to e.g.
 - Environmental issues
 - Farm diversification
- Improve quality of data
- Advantage of FADN: Link to farm performance
- EU-FADN is one of the main data sources for DG AGRI

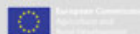

Unit L3

4

Proposals

Thus, the EU Commission proposes to broaden the scope of the farm return:

- **Collect more data relevant for environmental research**
 - **Fertiliser:**
 - Quantities of mineral NPK fertiliser used on the farm
 - Value of sold organic fertiliser
 - **More systematic info on irrigation**
 - Area of irrigated crops
 - Irrigation system used

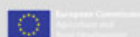

Unit L3

5

Proposals (2)?

- Area used for the production of energy crops
- Area used to produce GMO-crops
- Organic farming
 - Distinguish between the main farm activities
- Location of the farm:
 - Geo reference of the farm (use restricted to Commission services)
 - Location in Natura 2000 area
 - Location in water frame-directive areas

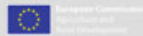

Unit L3

6

Proposals (3)?

- Collect more data on farm diversification
 - More systematic recording of OGA
 - Further processing of farm products
 - Forestry
 - Contractual work
 - Tourism
 - Renewable energy

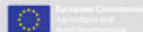

Unit L3

7

Proposals (4)?

- Improve precision and quality of data
 - Modernise the registration of assets and debts
 - Livestock: distinction between breeding and fattening activities
 - Farm costs: distinction between agriculture and OGA
 - Improved coherence with the FSS
 - Better recording of subsidies
 - Distinguish between EU and national support
 - Better separation of rural development and 1st Pillar support
- Modernise IT system



Unit L3

8

Process - What has been done

- Policy need known for a long time
- Formal discussions with MS started end of 2008
- Commission discussed the feasibility of the proposals with MS in the framework of
 - the FADN Committee and
 - many working group meetings



Unit L3

9

Next steps

- Committee vote
 - 14 November 2011
- Adoption in December?
- Implementation for accounting year 2013
- Phased implementation proposed for mineral fertilizers data – a 3-year transition period

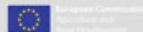

Unit L3

10

EU FADN

Presented by: Bernd Kuepker

Prepared by: Unit L.3

Website: <http://ec.europa.eu/agriculture/rica>

Contact: agri-rica-helpdesk@ec.europa.eu



Unit L3

11

Participant list

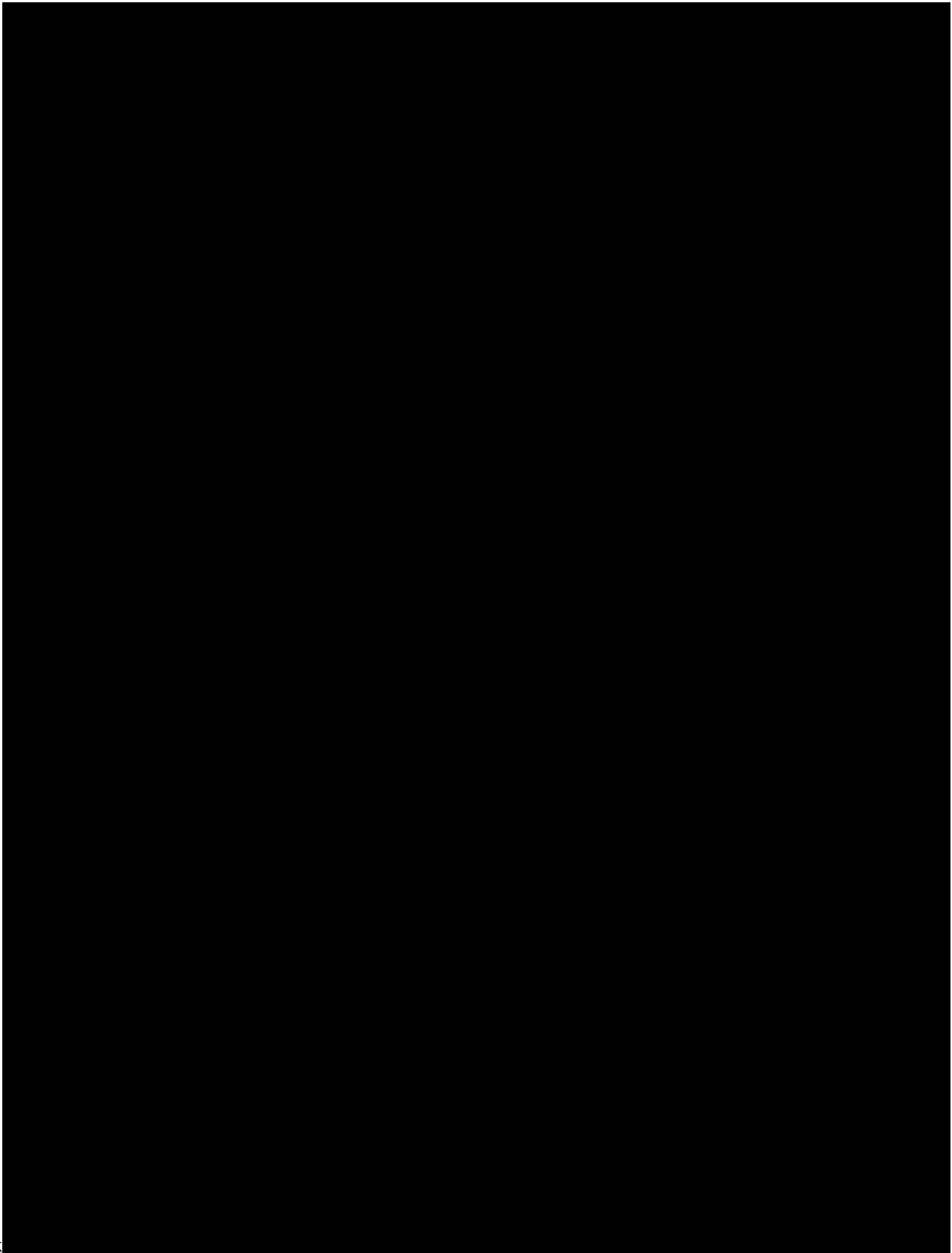

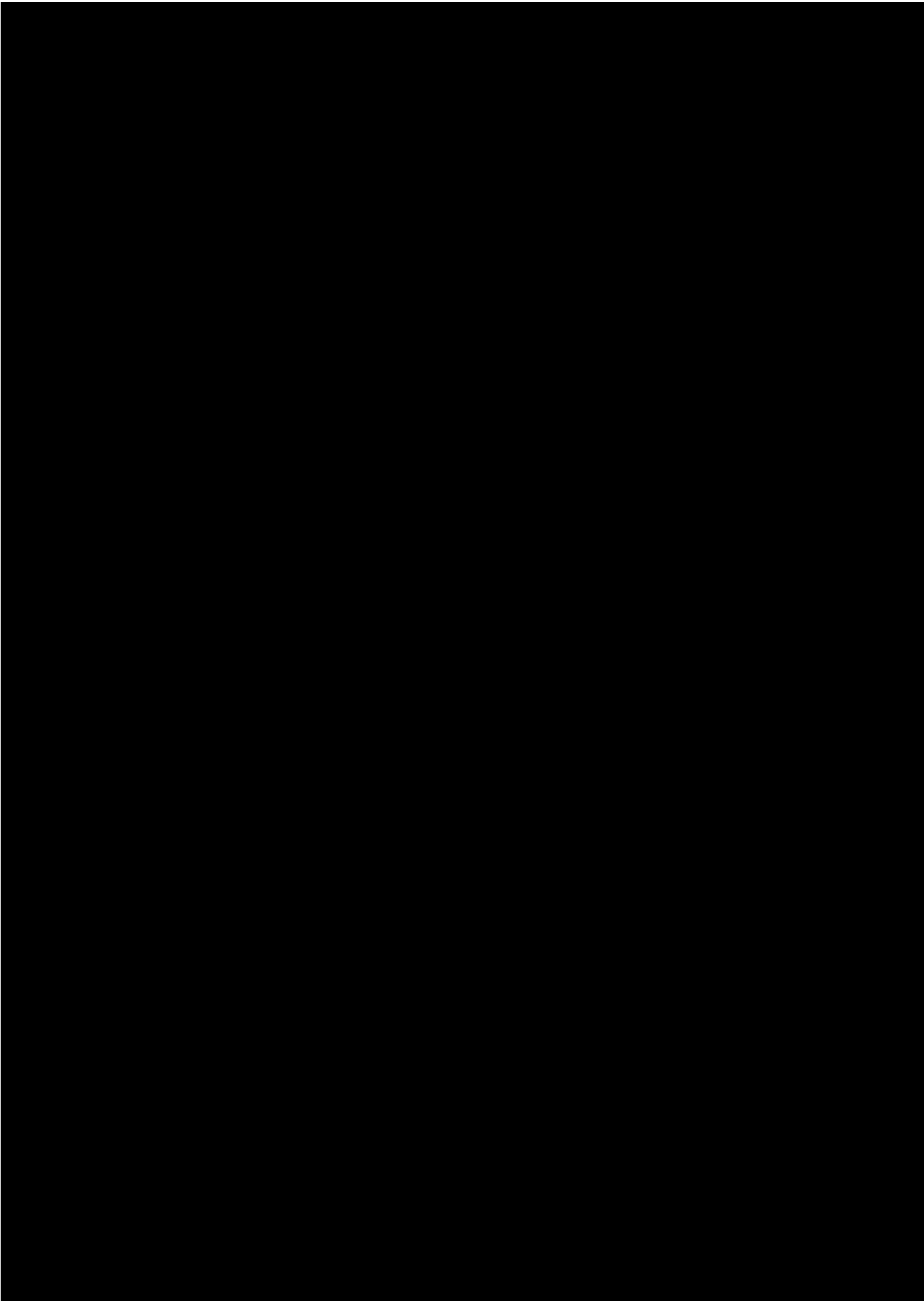

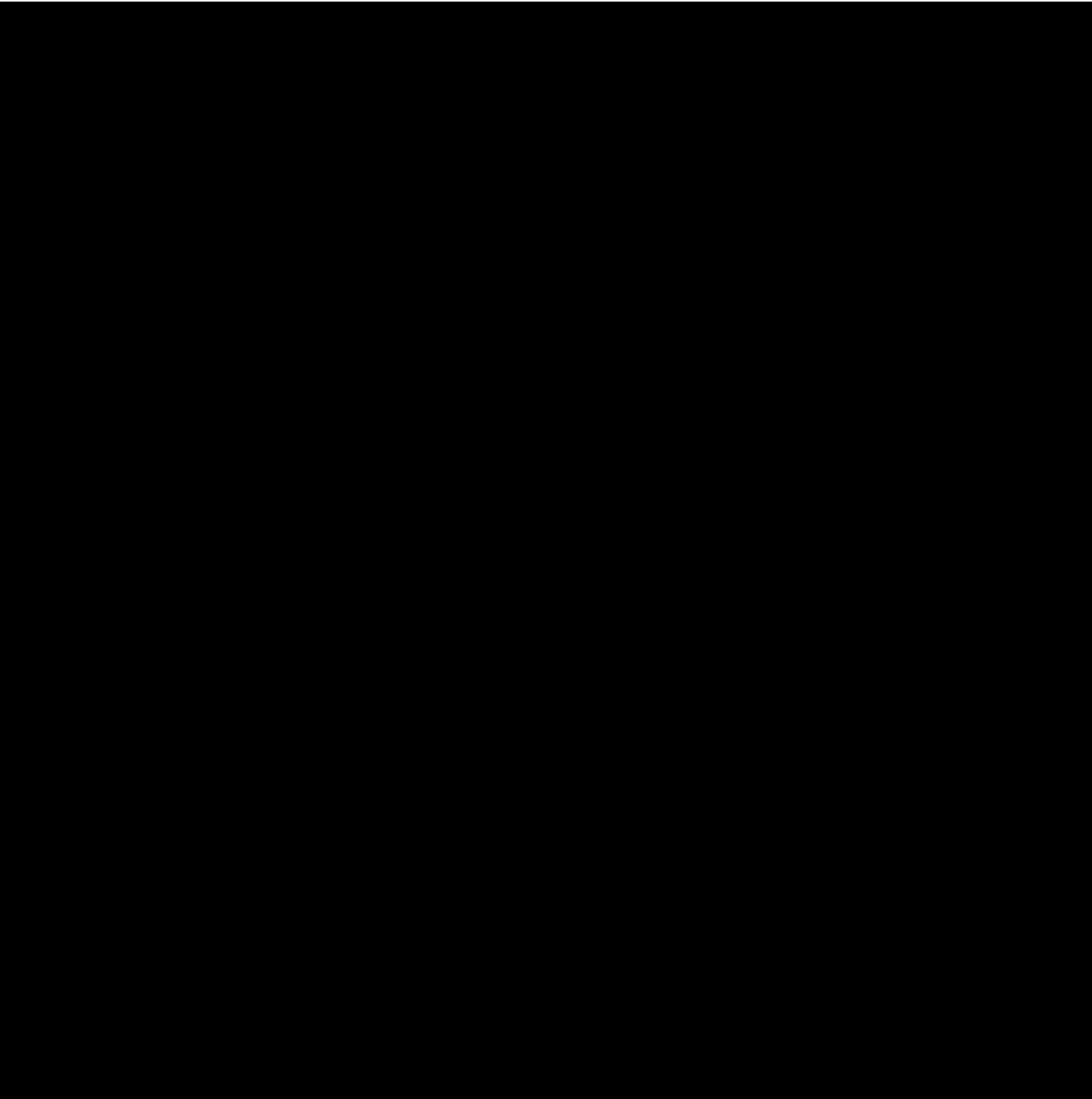

LEI develops economic expertise for government bodies and industry in the field of food, agriculture and the natural environment. By means of independent research, LEI offers its customers a solid basis for socially and strategically justifiable policy choices.

LEI is part of Wageningen UR (University & Research centre), forming the Social Sciences Group with the department of Social Sciences and Wageningen UR Centre for Development Innovation.

More information: www.lei.wur.nl

